

LBF Water Heaters



- Hot water recover rates from 76-1760 l/hr
- 75-400 storage capacity
- Fast recovery water heaters
- 3 year storage vessel warranty
- Vertical or horizontal balanced flue appliances



Lochinvar[®]
HIGH EFFICIENCY BOILERS & WATER HEATERS

LBF water heaters

LBF room sealed balanced flue water heaters offer all the advantages of Lochinvar's traditional Knight and Charger gas fired storage water heaters, but with the added benefit of having a concentric balanced flue. LBF water heaters draw air for combustion directly from outside, ensuring safe and reliable operation and offering significant installation cost savings when compared with conventionally flued units. They are particularly suitable for use in areas of negative pressure such as, for example, kitchens, eliminating potential 'spillage' that may be created where extractor fans are installed.



LBF81 and LBF121
water heaters

Lochinvar LBF water heaters feature baffled flueways for maximum heat transfer. Custom designed steel baffles are suspended within the flueways increasing the amount of heat transferred from the products of combustion to the water.

These combustion products are taken into a common header and discharged via the fan-assisted, concentric balanced flue, either horizontally or vertically.

All models can be installed using either horizontal or vertical flue assemblies. A basic flue kit is available from Lochinvar, as well as additional flue components including bends and flue pipe.

All models feature automatic ignition as standard and the facility to interface with building management systems is also available. The vitreous-enamelled steel tank is insulated in expanded polyurethane to reduce heat losses.

With storage capacities from 75 litres to 390 litres and recovery rates from 77 to 1760 litres/hour based upon a temperature rise of 50°C Lochinvar LBF water heaters offer a highly efficient solution for a wide variety of commercial and industrial applications.

LBF water heaters- dimensions (mm)

Model	LBF81	LBF121
A	1040	1400
B	850	1210
C	450	450
D	460	460
E	895	1255
F	100	100
G	60	60
H	500	500
I	200	200
J	50	50
K	200	200

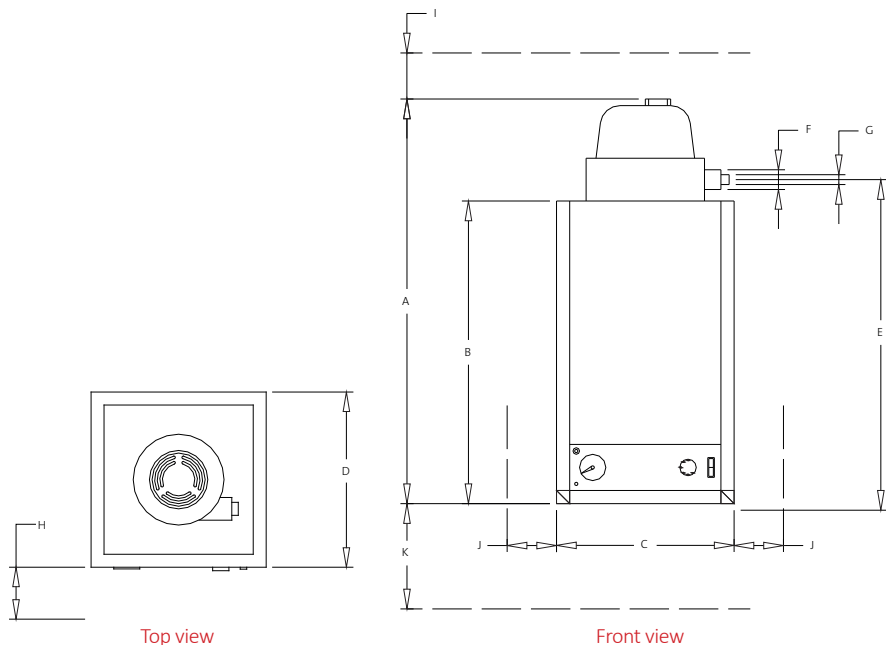

Models LBF81 | LBF121

These two models are extremely compact, wall mounted and have a flue diameter of only 60mm. Storage capacities are 75 litres and 115 litres respectively and both have a recovery rate of 77 litres/hour based upon a temperature rise of 50°C

The LBF81 and LBF121 are particularly suitable for smaller commercial and industrial applications providing low volume, instant hot water.

Features

- Wall mounted-saving on valuable floor space
- Automatic ignition
- Stainless steel burner
- Room sealed fan assisted flue
- A wide range of ancillaries - offering installation flexibility (refer to back page for details)
- Available for Natural Gas or LPG

Models LBF151 | LBF171 LBF221 | LBF301 | LBF401

These five models offer storage capacities from 145 to 390 litres and recovery rates from 276 to 458 litres/hour based upon a temperature rise of 50°C.

LBF water heaters are very compact, with models LBF151 and LBF171 having a footprint of only 520mm x 520mm. This along with the flueing options with all five models provides increased siting flexibility.

Concentric flue runs of up to 3m horizontal or 2m vertical are possible and up to 6m horizontal or vertical if using a twin pipe assembly. Additional flue components are available as ancillary options.

LBF151 to 171

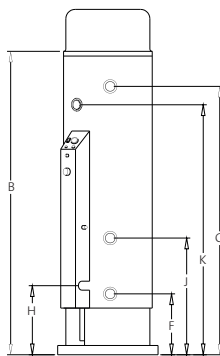

RH Side view

LBF221 to 401

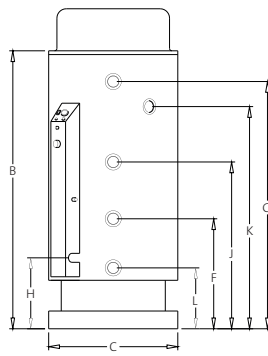

RH Side view

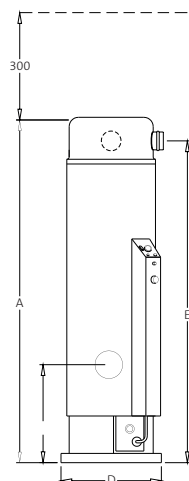

Front view

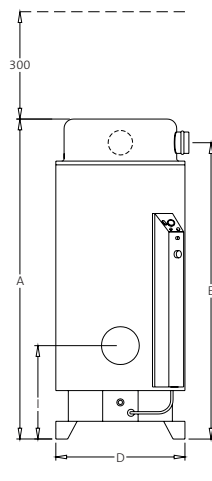

Front view

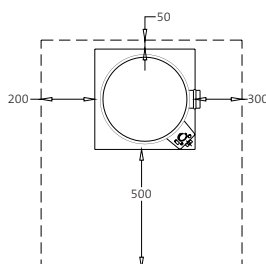

Top view

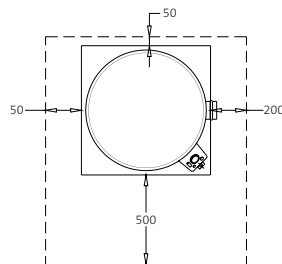

Top view



LBF171 and LBF301
water heaters

Features

- Automatic ignition
- Stainless steel burner
- Room sealed fan assisted flue
- A wide range of ancillaries- offering installation flexibility (refer to back page for details)
- Available for Natural Gas or LPG

LBF water heaters- dimensions (mm)

Model	LBF151	LBF171	LBF221	LBF301	LBF401
A	1905	2105	1560	1912	2275
B	1680	1880	1335	1687	2050
C	520	520	720	720	720
D	520	520	720	720	720
E	1790	1990	1445	1795	2145
F	395	395	570	570	570
G	1625	1825	1285	1640	1985
H	432	432	475	475	475
I	460	465	570	570	570
J	720	720	960	960	1135
K	1470	1670	1485	1835	1835
L	n/a	n/a	405	405	403

High output LBF range

Models LBF120GCE

LBF160GCE | LBF240GCE

LBF320GCE | LBF382GCE

The high output LBF range comprises five models with storage capacities of 253 to 309 litres. Recovery rates from 454 to 1760 litres/hour based upon a temperature rise of 50°C are achievable from these highly efficient water heaters. Concentric flue runs of up to 7m are possible providing increased siting flexibility and installation cost savings when compared with conventionally flued units.

High output LBF water heaters- dimensions (mm)

Model	LBF120GCE	LBF160GCE	LBF240GCE	LBF320GCE	LBF382GCE
A	2000	2000	2020	2020	2020
B	1800	1800	1820	1820	1820
C	1640	1640	1655	1655	1655
D	1600	1600	1600	1600	1600
E	770	770	760	760	760
F	600	600	590	590	590
G	600	600	600	600	760
H	550	550	540	540	540
I	125	150	200	130	130
J	80	100	130	130	130
K	755	755	755	755	755
L	-	-	-	235	235
M	580	580	580	580	580
N	1000	1000	1000	1000	1000



High output LBF
water heater

Features

- Automatic ignition
- Stainless steel burner
- Room sealed fan assisted flue
- Flame failure relay
- A wide range of ancillaries- offering installation flexibility (refer to back page for details)
- Available for Natural Gas or LPG

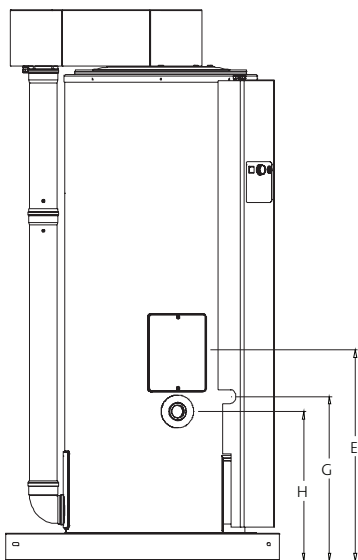

LH side view

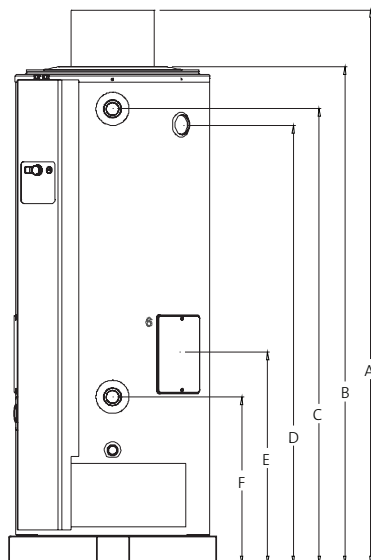

Front view

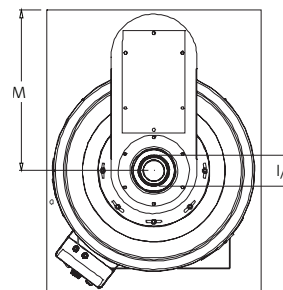

Concentric flue
top view LBF120 to 240GCE

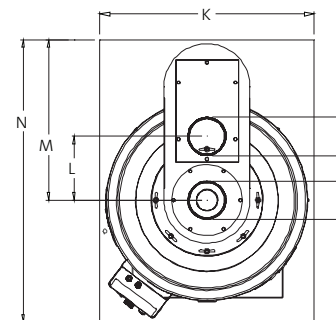

Twin pipe flue
top view LBF320 to 382GCE

Technical Information

Additional information, dimensional drawings and technical product submittals can be downloaded from our website: www.lochinvar.ltd.uk

Technical Specification

		LBF range							High output LBF range					
Water Heater Model		LBF81	LBF121	LBF151	LBF171	LBF221	LBF301	LBF401	LBF120GCE	LBF160GCE	LBF240GCE	LBF320GCE	LBF382GCE	
Nominal Input (net)	kW	5.0	5.0	18.0	19.0	25.0	29.0	29.0	29.0	47.0	75.0	102.0	115.0	
Nominal Input (gross)	kW	5.6	5.6	20.0	21.1	27.8	32.2	32.2	32.2	52.2	83.3	113.3	127.7	
Gas Flow Rate (natural gas)	m ³ /hr	0.52	0.52	1.85	1.96	2.58	2.99	2.99	3.1	5.1	7.9	10.8	12.2	
Nominal Output	kW	4.5	4.5	16.1	16.6	24.3	27.4	26.6	26.4	42.3	67.5	90.8	102.4	
EFFICIENCY DATA-Part L2														
Seasonal Efficiency (Part L2 Gross CV)	%	80.4	80.4	80.4	78.7	87.4	85.0	82.7	82.0	81.0	81.0	80.0	80.0	
NOx emission @0% O ₂	ppm	57	108	64	78	130	92	72	141	134	134	140	134	
NOx emission @0% O ₂	mg/kWh	100	190	113	138	229	162	126	248	235	235	246	235	
EFFICIENCY DATA-ErP and Energy Label														
Ecodesign Energy Label rating		B	B	B	B	B	B	B	B	B	B	n/a	n/a	
Water Heater efficiency	%	52	63	70	69	63	69	79	60	62	60	67	67	
GENERAL DATA														
Recovery Rate @ 44°C	l/hr	88	88	314	325	474	535	520	516	827	1319	1774	2000	
Recovery Rate @ 50°C	l/hr	77	77	276	286	417	471	458	454	728	1161	1561	1760	
Recovery Rate @ 56°C	l/hr	69	69	247	255	372	420	409	405	650	1036	1394	1572	
Dimensions (height)	mm	1040	1400	1905	2105	1560	1912	2275	2000	2000	2020	2020	2020	
Dimensions (width)	mm	450	450	520	520	720	720	720	755	755	755	755	755	
Dimensions (depth)	mm	460	460	520	520	720	720	720	1000	1000	1000	1000	1000	
Storage Capacity	litres	75	115	145	160	220	300	390	309	298	253	253	253	
Weight (Empty)	kg	49	74	128	141	220	265	309	230	245	295	320	320	
Weight (full)	kg	124	189	273	301	440	565	699	539	543	548	573	573	
Insulation Thickness	mm	50	50	50	50	50	50	50	50	50	50	50	50	
Insulation Material		Polyurethane/Rockwool												
Hot Outlet Connection (inches)	BSP	½	½	¾	¾	1¼	1¼	1¼	Rp1½	Rp1½	Rp1½	Rp1½	Rp1½	
Cold Feed Connection (inches)	BSP	½	½	¾	¾	1¼	1¼	1¼	R1½	R1½	R1½	R1½	R1½	
Gas Connection (inches)	BSP	¾	¾	½	½	½	½	½	Rp¾	Rp¾	Rp¾	Rp¾	Rp1	
Electrical Requirements		230V /1Ph/ 50hz												
Power Consumption	W	26	26	67	67	67	67	67	100	100	100	275	300	
Sound Power Level	LWA(db)	45	45	51	51	51	51	51	49	49	49	64	64	
Max Flue Gas Temperature	°C	99	88	109	95	109	115	97	130	150	145	180	185	
Max Outlet Temperature	°C	77	77	70	70	70	70	70	73	73	73	73	73	
Minimum Working Pressure	bar	0.5	0.5	0.5	0.5	0.5	0.5	0.5	0.5	0.5	0.5	0.5	0.5	
Maximum Working Pressure	bar	6.0	6.0	6.0	6.0	6.0	6.0	6.0	8.0	8.0	8.0	8.0	8.0	

Energy Label, Product Fiche and ErP Data Table are available at www.lochinvar.ltd.uk

* **Note:** LBF range- dimensions to top of flue fan housing

High output LBF range- dimensions to top of flue spigot

Flue installation

When calculating the length of your flue installation the following should be taken into consideration;

LBF range

Each 90j bend and 45j bend is equivalent to 1m flue distance.

High output LBF range

A maximum of two 90j or two 45j bends are allowed within the 7m flue run.

LBF water heater ancillary options

- Flame failure relay (LBF81- LBF401)
- Unvented system kits
- Direct storage vessels
- Correx® non sacrificial electrical anodes
- Horizontal or vertical room sealed concentric flue assemblies
- Room sealed twin pipe flue assemblies (LBF81- LBF401)
- De-stratification pump kit

Dakota Hotel, Nottingham

Hot water for the 92 bedroom hotel supplied by 3 x high output LBF water heaters.



Morrisons Supermarket

Hot water supplied by our LBF and high output LBF range of water heaters.



For further information on Installation requirements please see our ICM Instruction Manuals which are available on the Download section of our website - www.lochinvar.ltd.uk



Lochinvar Ltd reserves the right to change specifications without prior notice