

TECHNICAL PRODUCT SUBMITTAL

LOKE8-75



		LOKE8-75
Output		
Heat Transfer Duty	kW	75
Thermal efficiency	%	99.5
Primary Side		
Inlet Temperature	°C	75
Outlet Temperature	°C	40
Fluid Flow Rate	litre/second	0.51
pressure drop	bar	0.28
Connection size and type	Inch	1"
Max Working Temperature	°C	100
Maximum Working Pressure	bar	10
Secondary Side		
Inlet Temperature	°C	10
Outlet Temperature	°C	65
Fluid Flow Rate	litres/second	0.33
pressure drop	bar	0.11
Connection size and type	Inch	1"
Max Working Temperature	°C	95
Maximum Working Pressure	bar	10
Performance		
Recovery Rate @ 55°C ΔT	litres/hour	1188
Recovery Rate @ 55°C ΔT	litres/second	0.33
Recovery Rate @ 50°C ΔT	litres/hour	1307
Recovery Rate @ 50°C ΔT	litres/second	0.36
Dimensions		
Height without base	mm	835
Width without base	mm	710
Depth without base	mm	196
Construction Details		
Plate Material		AISI 316 Stainless Steel
Gasket Material		EPDM - Clip On
Empty weight	kg	65
Gasket WRAS Approval Number		1511532

LOKE Water heaters must be installed and maintained in line with the Installation Commissioning and Maintenance Instructions which are available on the Literature & Downloads section of www.lochinvar.ltd.uk

Particular attention should be made to:-

- Dimensions and clearances
- Vented and Unvented installation requirements
- maintenance

ErP and Warranty

ErP Data including Product Fiche and Energy Labels where applicable and Warranty information are also available at www.lochinvar.ltd.uk

TECHNICAL PRODUCT SUBMITTAL

LOKE8-75

LOKE without optional base

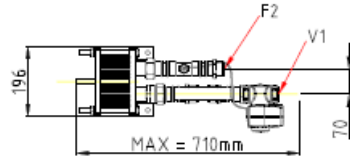

50-125 kW

PORT	CONNECTION TYPE	FUNCTION
V1	1" BSPT FEMALE	BOILER FLOW
F4	1" BSPT MALE	BOILER RETURN
F2	1" BSPT MALE	DHW OUT
F3	1" BSPT MALE	DWH IN

150-250 kW

PORT	CONNECTION TYPE	FUNCTION
V1	1.25" BSPT FEMALE	BOILER FLOW
F4	1.25" BSPT MALE	BOILER RETURN
F2	1.25" BSPT MALE	DHW OUT
F3	1.25" BSPT MALE	DWH IN

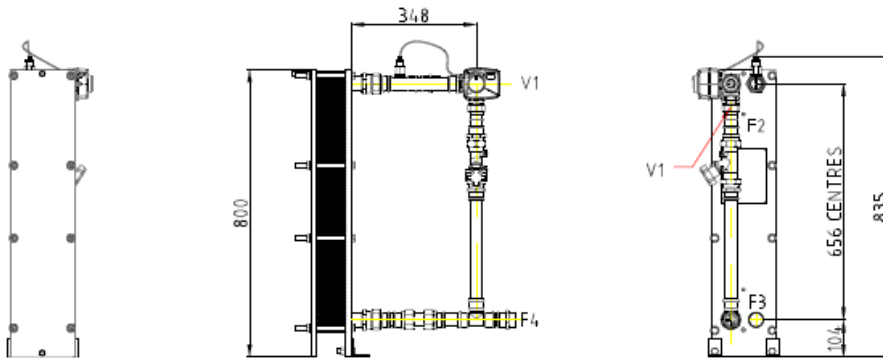

LOKE with optional base

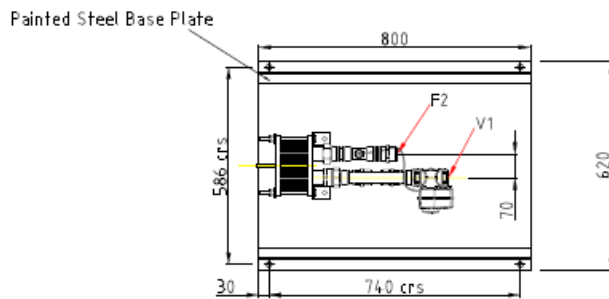

50-125 kW

PORT	CONNECTION TYPE	FUNCTION
V1	1" BSPT FEMALE	BOILER FLOW
F4	1" BSPT MALE	BOILER RETURN
F2	1" BSPT MALE	DHW OUT
F3	1" BSPT MALE	DWH IN

150-250 kW

PORT	CONNECTION TYPE	FUNCTION
V1	1.25" BSPT FEMALE	BOILER FLOW
F4	1.25" BSPT MALE	BOILER RETURN
F2	1.25" BSPT MALE	DHW OUT
F3	1.25" BSPT MALE	DWH IN

