

TECHNICAL PRODUCT SUBMITTAL

LBT3000 THERMAL STORE

LBT3000

EFFICIENCY DATA-Part L2	
Insulation Thickness	mm
Insulation Type	
Heat Loss	kWh/24h
EFFICIENCY DATA ErP AND ENERGY LABEL	
Ecodesign Energy Label rating	
Standing Loss	W
GENERAL DATA	
Storage Capacity	litres
Weight Empty	kg
Weight Full and Insulated	kg
Maximum Vessel Pressure	bar
Minimum Vessel Temperature	°C
Maximum Vessel Temperature	°C

100
Polyethylene
n/a
n/a
n/a
3000
340
3340
6
-10
90

The LBT Thermal store must be installed and maintained in line with the Installation Commissioning and Maintenance Instructions which are available on the Literature & Downloads section of www.lochinvar.ltd.uk

ErP and Warranty

ErP Data including Product Fiche and Energy Labels where applicable and Warranty information are also available at www.lochinvar.ltd.uk

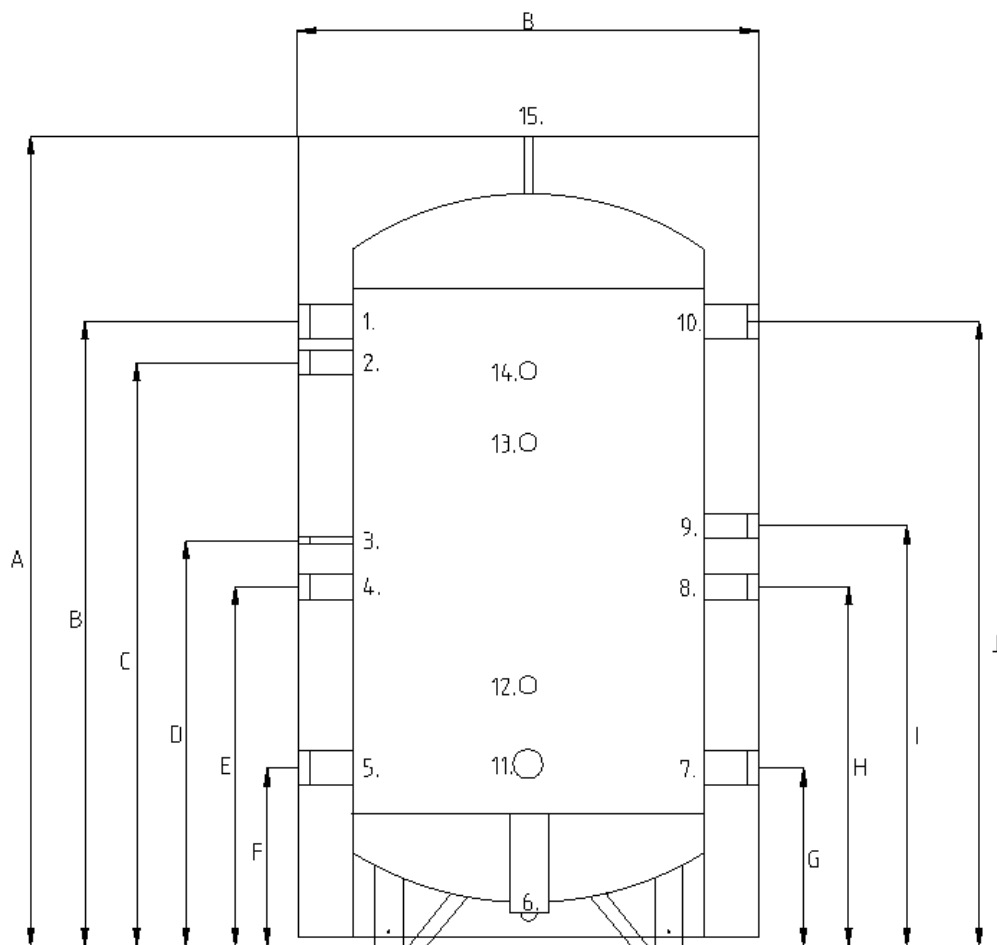

TECHNICAL PRODUCT SUBMITTAL

LBT3000 THERMAL STORE



No	Description	Unit	LBT2500	LBT3000	LBT4000	LBT5000
A	Total Height (with insulation)	mm	2360	2860	2930	2970
B	Diameter of Water Heater (with insulation)	mm	1470	1470	1620	1820
C	Height of Immersion heater connection	mm	565	565	590	600
D	Connection ASHP return	mm	565	565	590	600
E	Height of Tank body connection	mm	1005	1505	1530	1540
F	Height of Tank body connection	mm	565	565	590	600
G	Connection ASHP flow	mm	565	565	590	600
H	Height of Tank body connection	mm	1115	1365	1390	1400
I	Height of Tank body connection	mm	1315	1565	1590	1600
J	Height of Tank body connection	mm	1865	2365	2390	2400
A	Height of AAV Connection	mm	2360	2860	2930	2970

No	Description	Unit	LBT2500	LBT3000	LBT4000	LBT5000
1	Connection Heating System Flow	BSP	4"	4"	4"	4"
2	Connection Tank body	BSP	2"	2"	2"	2"
3	Connection Sensor Point	BSP	½"	½"	½"	½"
4	Connection Tank body	BSP	2"	2"	2"	2"
5	Connection Heating System Return	BSP	4"	4"	4"	4"
6	Connection Drain	BSP	2"	2"	2"	2"
7	Connection ASHP Return	BSP	4"	4"	4"	4"
8	Connection Tank Body	BSP	2"	2"	2"	2"
9	Connection Tank Body	BSP	2"	2"	2"	2"
10	Connection ASHP Flow	BSP	4"	4"	4"	4"
11	Connection Immersion heater	BSP	2"	2"	2"	2"
12	Connection Sensor Point	BSP	½"	½"	½"	½"
13	Connection Sensor Point	BSP	½"	½"	½"	½"
14	Connection Sensor Point	BSP	½"	½"	½"	½"
15	Connection Air Vent	BSP	2"	2"	2"	2"