

Amicus

Air to Water Heat Pumps

Installation, commissioning and maintenance instructions

Models

LAHP-252HT
LAHP-302HT
LAHP-452HT
LAHP-502HT
LAHP-602HT
LAHP-752HT
LAHP-852HT
LAHP-1002HT
LAHP-1202HT



READ AND UNDERSTAND THE INSTRUCTIONS



Read and fully understand all instructions before attempting to operate maintain or install the unit.

CONTENTS

1		
1	INTRODUCTION	5
	PRELIMINARY INFORMATION	5
	AIM AND CONTENT OF THE MANUAL	5
	HOW TO STORE THE MANUAL	5
	MANUAL UPDATES	5
2	HOW TO USE THIS MANUAL	6
	POTENTIAL RISKS	6
3	GENERAL DESCRIPTION OF SYMBOLS USED	7
	SAFETY SYMBOLS USED	8
	LIMITATIONS AND PROHIBITED USE	9
	UNIT IDENTIFICATION	9
4	SAFETY	10
	WARNING RE POTENTIALLY HAZARDOUS TOXIC SUBSTANCES	10
	MAIN ECOLOGICAL INFORMATION REGARDING THE TYPES OF REFRIGERANTS FLUIDS USED	10
	PERSISTENCE AND DEGRADATION	10
	EFFECTS OF DISCHARGES	10
	EXPOSURE CONTROLS AND PERSONAL PROTECTION	10
	REFRIGERANT HANDLING	10
	PREVENTION OF INHALATION OF HIGH VAPOUR CONCENTRATIONS	10
	PROCEDURES IN THE EVENT OF ACCIDENTAL RELEASE OF REFRIGERANT	11
	MAIN TOXICOLOGICAL INFORMATION ON THE TYPE OF REFRIGERANT USED	11
	4.1.1 <i>Inhalation</i>	11
	4.1.2 <i>Contact with skin</i>	11
	4.1.3 <i>Contact with eyes</i>	11
	4.1.4 <i>Ingestion</i>	11
	FIRST AID MEASURES	11
	4.1.5 <i>Inhalation</i>	11
	4.1.6 <i>Contact with skin</i>	11
	4.1.7 <i>Contact with eyes</i>	11
	4.1.8 <i>Ingestion</i>	11
	4.1.9 <i>Further medical treatment</i>	11
5	TECHNICAL CHARACTERISTICS	12
	UNIT DESCRIPTION	12
	NOISE REDUCTION	12
	REFRIGERANT CIRCUIT	12
	COMPRESSORS	12
	SOURCE HEAT EXCHANGER	13
	FANS	13
	USER HEAT EXCHANGERS	13
	ELECTRIC ENCLOSURE	13
	MICROPROCESSORS	13
	CONTROL AND PROTECTION DEVICES	14
	CONDENSATE DISCHARGE DRIP TRAY WITH ANTIFREEZE HEATER	14
	ANTIFREEZE KIT	14
	USER WATER STRAINER	14
	USER FLOW SWITCH	14
6	ACCESSORIES	14
7	WHAT IS EVI	15
	7.1.1 <i>E.V.I flow diagram</i>	15
	7.1.2 <i>Amicus Operational limits</i>	16
8	TECHNICAL DATA	17
	TECHNICAL DATA TABLES	17
	DIMENSIONS AND WEIGHTS	18
9	OPERATION LIMITS	19
	9.1.1 <i>Operational limits of the amicus range</i>	19

HEAT EXCHANGER WATER PRESSURE DROPS	19
USER HOT WATER TEMPERATURE	20
AMBIENT AIR TEMPERATURE	20
10 DOMESTIC HOT WATER PRODUCTION	21
SIZING INDIRECT CYLINDER COILS	21
11 CORRECTION TABLES	22
OPERATION WITH GLYCOL	22
11.1.1 Correction tables different Δt	22
11.1.2 Correction tables different fouling factors.....	22
SOUND DATA	22
GENERAL SAFETY GUIDELINES AND THE USE OF SYMBOLS	23
HEALTH AND SAFETY INFORMATION	23
PPE	23
INSPECTION	24
BEFORE ACCEPTING THE UNIT CHECK:	24
IN CASE OF DAMAGE	24
STORAGE	24
UNPACKING	24
LIFTING AND HANDLING	25
CLEARANCES	26
INSTALLATION OF RUBBER VIBRATION DAMPERS	27
SERIAL INTERFACE CARD	27
CONDENSATE DRIP TRAY	27
HYDRAULIC CONNECTIONS	29
WATER QUALITY	29
HYDRAULIC COMPONENTS.....	30
11.1.3 pipework connections.....	30
USER CIRCUIT (HEATING CIRCUIT) MINIMUM WATER CONTENT	31
DOMESTIC HOT WATER MINIMUM WATER CONTENT	31
FILLING THE HYDRAULIC CIRCUIT	31
EMPTYING THE INSTALLATION	31
TYPICAL INSTALLATION SCHEMATICS	32
11.1.4 Solutions guide Legend for drawings on 11.23.2 to 11.23.9.....	32
11.1.5 Solution 1- Amicus providing heating only	33
11.1.6 Solution 2- Amicus providing heating and domestic hot water via a plate and buffer.....	34
11.1.7 Solution 3-Amicus providing pre-heated domestic hot water to a direct gas fired water heater via an HSV thermal store	35
11.1.8 Solution 4 – Amicus providing heating and pre heated domestic hot water to a direct gas fired water heater via an HSV thermal store.....	36
11.1.9 Solution 5 – Amicus providing heating and pre heated domestic hot water to a direct gas fired water heater via an HSV thermal store with gas condensing boiler support	37
11.1.10 Solution 6-Amicus providing heating with gas condensing boiler support	38
11.1.11 Solution 7- Amicus providing domestic hot water only via a plate and buffer.....	39
11.1.12 Solution 8 – Amicus providing heating and domestic hot water via an indirect cylinder suitable for small DHW loads only	40
12 WIRING CONNECTIONS	41
ELECTRICAL DATA	42
ELECTRICAL CONNECTIONS	42
REMOTE WIRING CONNECTIONS (COMPULSORY)	43
REMOTE WIRING CONNECTIONS (OPTIONAL).....	44
FACTORY FITTED WIRING CONNECTIONS	44
POSITIONING OF THE USER CIRCUIT WATER SENSOR (BTI)	45
POSITIONING OF THE DOMESTIC HOT WATER SENSOR (BTS).....	45
REFRIGERANT CIRCUIT LAYOUT	46
13 UNIT START UP	47
PRELIMINARY CHECKS	47
BEFORE START-UP	47
DEVICE SET-POINT DIFFERENTIAL RESET	48
CONTROLS DURING UNIT OPERATION.....	48
REFRIGERANT CHARGE CHECKING	48
14 CONTROL PANEL	49
POSITION OF THE CONTROL PANEL	49
DISPLAY ICONS	49
KEY FUNCTION.....	50

14.1.1	<i>Display on start up</i>	50
	REMOTE CONTROL PANEL OPTION.....	50
	CONNECTING THE REMOTE CONTROL PANEL.....	51
	PANEL MOUNTING CONNECTION DIAGRAM.....	51
	WALL MOUNTING CONNECTION DIAGRAM.....	51
	SWITCHING THE UNIT ON.....	52
14.1.2	<i>Heating Mode</i>	52
14.1.3	<i>Domestic hot water mode</i>	52
14.1.4	<i>Standby mode</i>	52
14.1.5	<i>Heating</i>	52
14.1.6	<i>Switch the unit on from digital input</i>	53
14.1.7	<i>STOP</i>	53
	HOW TO CHANGE SET POINTS.....	54
	USER ADJUSTABLE PARAMETERS.....	54
	PROBES KEY.....	55
	ALARM KEY.....	55
	CIRC KEY.....	56
	SERVICE KEY.....	58
	SERVICE PARAMETER SETTING.....	59
	WEATHER COMPENSATION FUNCTION.....	61
	SETTING THE DATE AND TIME.....	62
	COMPRESSOR MAINTENANCE.....	63
	WATER PUMPS.....	63
	CIRCUIT MAINTENANCE.....	63
14.1.8	<i>Alarm log</i>	64
	DEFROST.....	64
	ELECTRICAL HEATER.....	65
	STATUS INPUT/OUTPUT.....	65
	SCREW COMPRESSOR.....	66
	AUXILIARY OUTPUT.....	66
	SANITARY (DOMESTIC) HOT WATER.....	67
	UPLOAD/DOWNLOAD.....	67
	CONTROL PANEL.....	67
	ACOUSTIC SIGNAL SILENCE.....	68
15	UNIT MAINTENANCE	68
	GENERAL WARNINGS.....	68
	ACCESS TO THE UNIT.....	68
	PERIODICAL CHECKS.....	68
15.1.1	<i>Every Six Months</i>	69
15.1.2	<i>End of seasons or unit switched off:</i>	69
16	REFRIGERANT CIRCUIT REPAIR	70
17	DECOMMISSIONING	71
	DISCONNECT THE UNIT.....	71
18	DISPOSAL, RECOVERY AND RECYCLING	71
19	RAEE DIRECTIVE	71
20	TROUBLESHOOTING	72
	FAULT FINDING.....	72

1 INTRODUCTION

PRELIMINARY INFORMATION

Reproduction, storage or transmission of any part of this publication in any form, without the prior written consent of the Company, is prohibited.

The unit, to which these instructions refer, is designed to be used for the purposes described and to be operated in accordance with these instructions.

The Company will not be liable for claims for damage caused to persons, animals, material goods or property caused by improper installation, adjustment and maintenance or improper use. Any use not specified in this manual is prohibited.

This document is intended to provide information only and does not form a contract with third parties.

The Company pursues a policy of constant improvement and development of its products and therefore reserves the right to change the specifications and the documentation at any time, without notice and without obligation to update existing equipment.

AIM AND CONTENT OF THE MANUAL

These instructions are intended to provide the information required for the selection, installation, use and maintenance of the unit.

They have been prepared in accordance with the European Union laws and with the technical standards in force at the date of issue of the instructions.

The instructions contain all the necessary information to prevent any reasonably foreseeable misuse.

HOW TO STORE THE MANUAL

The manual must be kept in a suitable place with easy access for users and operators, protected from dust and damp.

The manual must always accompany the unit during the entire life cycle of the same and therefore must be transferred to any subsequent user.

MANUAL UPDATES

It is recommended that the manual is updated to the latest revision available.

If updates are sent to the customer, they must be added to this manual.

The latest information regarding the use of its products is available by contacting Lochinvar Limited.

2 HOW TO USE THIS MANUAL



The manual is an integral part of the unit.

Users or operators must consult the manual before performing any operation and especially so when transporting, handling, installing, maintaining, or dismantling the unit in order to eliminate uncertainty and reduce risk.

In these instructions symbols have been used (described in the following paragraphs) to draw the attention of operators and users to the operations that have a higher risk and which must be performed safely.

POTENTIAL RISKS

Whilst the unit has been designed to minimise any risk posed to the safety of people who will interact with it, it has not been technically possible to eliminate the causes of risk. Please ensure suitable PPE is worn whilst working on the equipment taking note of all safety precautions in the table below and within the document.

LOCATION OF RISK	POTENTIAL RISK	METHOD OF INJURY	PRECAUTIONS
Thermal heat exchangers	Small stab wounds	Contact	Avoid contact, wear suitable PPE
Fan and fan grills	Cuts, eye damage, broken bones	Insertion of object through the grill while the fans are operating	Never insert objects through the grills
Internal components, compressors and discharge pipes	Burns	Contact	Avoid contact, wear suitable PPE
Internal component, electric cable and metallic parts	Electrocution, severe burns	Defect in the supply cable insulation, live metallic parts	Adequate protection of all cables, correct earthing of the unit
External to unit, unit enclosure	Poisoning, severe burns	Fire due to short circuit, or overheating to the supply cable	Size cables and mains protection systems in accordance with regulations in force
Low pressure safety valve	Poisoning, severe burns	High evaporating pressure causing a refrigerant discharge during maintenance	Carefully check the evaporating pressure during maintenance operations
High pressure safety valve	Poisoning, severe burns, hearing loss	Activation of the high pressure safety valve with the refrigerant circuit open	If possible do not open the refrigerant circuit valve, carefully check the condensing pressure wear suitable PPE
Entire unit	External fire	Fire due to external sources nearby	Provide suitable firefighting equipment

3 GENERAL DESCRIPTION OF SYMBOLS USED

Safety symbols combined in accordance with ISO 3864-2:



BANNED

A black symbol inside a red circle with a red diagonal indicates an action that should not be performed



WARNING

A black symbol added to a yellow triangle with black edges indicates danger



ACTION REQUIRED

A white symbol inserted in a blue circle indicates an action that must be taken to avoid risk

Safety symbols combined in accordance with ISO 3864-2:



The graphic symbol “warning” is qualified with additional safety information (data or text)

SAFETY SYMBOLS USED



GENERAL RISK

Observe all signs placed next to the pictogram. The failure to follow directions may create a risk situation that could be dangerous to others



ELECTRICAL HAZARD

Observe all signs placed next to the pictogram. The symbol indicates components of the unit and actions described in this manual that could create an electrical hazard.



MOVING PARTS

The symbol indicates those moving parts of the unit that could create risk



HOT SURFACES

The symbol indicates those components with a high surface temperature that could create a risk.



SHARP SURFACES

The symbol indicates components or parts that could cause stab wounds



EARTH CONNECTION

The symbol identifies earth connection points on the unit.



READ AND UNDERSTAND THE INSTRUCTIONS

Read and fully understand all instructions before attempting to operate, maintain or install the unit.



RECOVER OR RECYCLE MATERIAL

LIMITATIONS AND PROHIBITED USE

The machine is designed and built exclusively for the uses described in "Limitations of use" of the technical manual. Any other use is prohibited because it may pose a potential risk to the health of operators and users.



The unit is not suitable for use in environments with:





- Excessively dusty or potentially explosive atmospheres
- Where there are vibrations
- Where there are electromagnetic fields
- Where there are aggressive atmospheres

UNIT IDENTIFICATION

Each unit has a rating plate that provides key information regarding the machine.

The rating plate may differ from the one shown below as the example is for a standard unit without accessories. For all electrical information not provided on the label, refer to the wiring diagram.

A facsimile of the label is shown below:

		Manufacturer: PD02111 
Via E. Mattei, 20 35020 Piove di Sacco PD - Italy +39 049 9731022 info@hidros.it www.hidros.eu		
1LZT.0302.NNRV2U-1A <small>Modello Model</small>		123456 <small>Matricola Serial number</small>
2 <small>Categoria PED PED Category</small>		3/2017 <small>Data di fabbricazione Manufacture date</small>
R410A <small>Tipo refrigerante Refrigerant type</small>	2 <small>Gruppo fluido Fluid group</small>	2088 <small>GWP</small>
C1 10 Kg <small>C3</small>	C2 10 Kg <small>C4</small>	20,88 ton <small>CO₂ Equivalente CO₂ Equivalente</small>
400V-3ph+N-50Hz <small>Tensione-Fasi-Frequenza Voltage-Phases-Frequency</small>	24,50 A <small>F.L.A. (A)</small>	13,50 kW <small>F.L.L. (kW)</small>
LATO BASSA PRESSIONE <small>LOW PRESSURE SIDE</small>		LATO ALTA PRESSIONE <small>HIGH PRESSURE SIDE</small>
29,5 bar <small>PS</small>		53 bar <small>PS</small>
Min -30 °C <small>Temperatura di progetto Design temperature</small>	Max +130 °C <small>Temperatura di progetto Design temperature</small>	Min -30 °C <small>Temperatura di progetto Design temperature</small>
Max +130 °C <small>Temperatura di progetto Design temperature</small>		
<small>Peso a vuoto Weight</small>		
<small>Contiene gas fluorurati ad effetto serra disciplinati dal protocollo di Kyoto Contains fluorinated greenhouse gases covered by the Kyoto protocol</small>		



The product label must never be removed from the unit

4 SAFETY

WARNING RE POTENTIALLY HAZARDOUS TOXIC SUBSTANCES

Identification of the Type of Refrigerant Fluid Used: R410A

- Difluoromethane (HFC-32) 50% by weight CAS No.: 000075-10-5
- Pentafluoroethane (HFC-125) 50% by weight CAS No.: 000354-33-6

The lubricant used is polyester oil. Please refer to the information provided on the compressor data plate.



For further information regarding the characteristics of the refrigerant and oil used refer to the safety data sheets available from the manufactures of the refrigerant and oil.

MAIN ECOLOGICAL INFORMATION REGARDING THE TYPES OF REFRIGERANTS FLUIDS USED.



Environmental protection: read the ecological information and the following paragraphs carefully.

PERSISTENCE AND DEGRADATION

The refrigerants used decompose in the lower atmosphere (troposphere) relatively quickly. The decomposed products are highly dispersible and therefore have a very low concentration. They do not influence the photochemical smog which is not among the VOC volatile organic compounds (as stipulated in the guidelines to the UNECE). The constituent refrigerants of R410A, do not damage the ozone layer. These substances are regulated under the Montreal Protocol (revised 1992) and regulations EC no. 2037/200 of 29 June 2000.

EFFECTS OF DISCHARGES

A discharge into the atmosphere of this product does not cause a long-term contamination.

EXPOSURE CONTROLS AND PERSONAL PROTECTION

Wear protective clothing and gloves; protect your eyes and face

Professional exposure limits

R410A	
HFC-32	TWA 1000 ppm
HFC-125	TWA 1000 ppm

REFRIGERANT HANDLING



Users and maintenance personnel must be adequately informed about the possible risks of handling potentially toxic substances. Failure to follow such instructions can cause damage to personnel or the unit.

PREVENTION OF INHALATION OF HIGH VAPOUR CONCENTRATIONS

Atmospheric concentrations of refrigerant must be minimised and kept to a level that is below the occupational exposure limit. Vapour is heavier than air and can form dangerous concentrations near the ground where the ventilation rate is lower. Always ensure adequate ventilation. Avoid contact with open flames and hot surfaces as this can cause toxic and irritating decomposition products to form. Avoid contact between liquid refrigerant and the eyes or skin.

PROCEDURES IN THE EVENT OF ACCIDENTAL RELEASE OF REFRIGERANT

Ensure suitable personal protection (especially respiratory protection) during cleaning operations.

If deemed safe, isolate the source of the leak. If the leakage is small and if adequate ventilation is provided, allow the refrigerant to evaporate. If the loss is substantial, ensure that measures are taken to adequately ventilate the area.

- Contain spilled material with sand, earth or other suitable absorbent material.
- Do not allow the refrigerant to enter drains, sewers or basements, as pockets of vapour can form.

MAIN TOXICOLOGICAL INFORMATION ON THE TYPE OF REFRIGERANT USED

4.1.1 INHALATION

A high atmospheric concentration can cause anaesthetic effects with possible loss of consciousness. Prolonged exposure may lead to irregular heartbeat and cause sudden death. Higher concentrations may cause asphyxia due to the reduced oxygen content in the atmosphere.

4.1.2 CONTACT WITH SKIN

Splashes of nebulous liquid can produce frostbite. Probably not hazardous if absorbed through the skin. Repeated or prolonged contact may remove the skin's natural oils, with consequent dryness, cracking and dermatitis.

4.1.3 CONTACT WITH EYES

Splashes of liquid may cause frostbite.

4.1.4 INGESTION

While highly improbable, may produce frostbite

FIRST AID MEASURES



The following warnings and procedures must always be strictly adhered to.

4.1.5 INHALATION

Move the person away from the source of exposure, keep him/her warm and let him/her rest. Administer oxygen if necessary. Attempt artificial respiration if breathing has stopped or shows signs of stopping. If the heart stops, perform external heart massage. Seek medical assistance.

4.1.6 CONTACT WITH SKIN

In case of contact with skin, wash immediately with lukewarm water. Thaw tissue using water. Remove contaminated clothing. Clothing may stick to the skin in case of frostbite. If irritation, swelling or blisters appear, seek medical assistance.

4.1.7 CONTACT WITH EYES

Rinse immediately using an eyewash or clean water, keeping eyelids open, for at least ten minutes. Seek medical assistance.

4.1.8 INGESTION

Do not induce vomiting. If the injured person is conscious, rinse his/her mouth with water and make him/her drink 200-300ml of water. Seek immediate medical assistance.

4.1.9 FURTHER MEDICAL TREATMENT

Treat symptoms and carry out support therapy as indicated. Do not administer adrenaline or similar sympathomimetic drugs following exposure, due to the risk of cardiac arrhythmia.

5 TECHNICAL CHARACTERISTICS

UNIT DESCRIPTION

The AMICUS series of high efficiency heat pumps has been specifically designed for use with radiant floor heating systems or those applications where it is necessary to have maximum efficiency when heating. They have been optimised on heating mode, are able to produce water up to 63°C and can operate down to -20°C ambient temperature.

All versions are supplied with a reverse cycle valve used for winter defrost; noise is extremely low thanks to the use of a special floating vibration damping system which gives a noise reduction of about 10-12 dB (A).

All AMICUS units are made from hot-galvanised sheet steel, painted with polyurethane powder enamel and baked at 180°C to provide maximum protection against corrosion. The frame is self-supporting with removable panels. All screws and rivets used are made from stainless steel. The standard colour of the units is RAL9018.

NOISE REDUCTION

All AMICUS units are supplied, as standard, with the latest 'Floating Frame' technology that completely isolates the compressors from the main casing, thereby eliminating vibration and noise from this source. The 'Floating Frame' is a special vibration and acoustic damping system that consists of a base plate and acoustic enclosure that houses the compressors. The base plate is separated from the supporting frame of the unit by soft steel springs that have a high damping power. Within the enclosure, the compressors are mounted on rubber shock absorbers on the floating base plate. The enclosure is manufactured from galvanized steel sandwich panels that have a micro-perforated inner skin and a core of 50 mm thick, high density (40 kg/m³) mineral wool. The entire arrangement provides a double damping system and acoustic attenuation. The compressor refrigerant pipes are connected to the 'fridge circuit' via "anaconda" flexible connections. Flexible connections are also used on the water pipework within the unit. The combination of these systems results in an overall noise reduction in the region of 10-12 dB (A).

REFRIGERANT CIRCUIT

The refrigerant utilised is R410A. The refrigerant circuit is assembled using internationally recognised brand name components with all brazing and welding being performed in accordance with ISO 97/23. The refrigerant circuit includes: sight glass, filter drier, two thermal expansion valves with external equalizer, 4 way reversing valve, check valves, liquid receiver, Schrader valves for maintenance and control, pressure safety device (for compliance with PED regulations). The circuit also includes an AISI316 stainless steel heat exchanger that is used as an economizer plus an additional expansion valve for refrigerant vapour injection.

COMPRESSORS

Units use scroll compressors that are equipped with E.V.I. technology, a versatile method of improving system capacity and efficiency. EVI stands for "Enhanced Vapour Injection." The technology involves injecting refrigerant vapour into the middle of the compression process, a procedure that significantly boosts capacity and efficiency. Each scroll compressor used in these units is similar to a two-stage compressor with built-in inter-stage cooling. The process begins when a portion of the condenser liquid is extracted and expanded through an expansion valve. The low temperature liquid/gas mixture produced is injected into a heat exchanger that operates as a sub cooler. Any liquid is evaporated and the vapour produced is superheated. The superheated vapour is then injected into an intermediate port in the scroll compressor. This cold vapour reduces the temperature of the compressed gas thus enabling the compressor to raise the pressure to levels (and temperatures) beyond that possible with a single stage scroll. The additional sub cooling of the main volume of liquid refrigerant increases the evaporator capacity. This compressor technology generates a larger pressure ratio between condensing and evaporating pressures, with significant performance improvement. In all units the compressors are connected in tandem. The compressors are all supplied with a crankcase heater and thermal overload protection by a klixon embedded in the motor winding. They are mounted in a separate enclosure in order to be separated from the air stream thus enabling them to be maintained even if the unit is operating. Access to this enclosure is by the front panel of the unit. The crankcase heater is always powered when the compressor is in stand-by.

SOURCE HEAT EXCHANGER

The source heat exchanger is made from 3/8" copper pipes and 0,1mm thick aluminium fins with the tubes being mechanically expanded into the aluminium fins in order to maximise heat transfer. Furthermore, the design guarantees a low air side pressure drop thus enabling the use of low rotation speed (and hence low noise) fans.

FANS

The fans are direct drive axial type with aluminium aerofoil blades, are statically and dynamically balanced and are supplied complete with a safety fan guard complying with the requirements of EN 60335. They are fixed to the unit frame via rubber anti-vibration mountings. The electric motors are 8 poles type rotating at approximately 900 rpm. As standard, all units are fitted with a pressure operated fan speed controller. The motors are fitted with integrated thermal over-load protection and have a moisture protection rating of IP 54.

USER HEAT EXCHANGERS

The user heat exchanger is a brazed welded, plate type heat exchanger, manufactured from AISI 316 stainless steel. The use of this type of exchanger results in a large reduction of the refrigerant charge of the unit compared to a traditional shell-in-tube type. A further advantage is a reduction in the overall dimensions of the unit.

The exchangers are factory insulated with flexible close cell material and are fitted with an antifreeze heater. Each exchanger is fitted with a temperature sensor on the discharge water side for antifreeze protection.

ELECTRIC ENCLOSURE

The enclosure is manufactured in order to comply with the requirements of the electromagnetic compatibility standards CEE 73/23 and 89/336. Access to the enclosure is achieved by removing the front panel of the unit. The following components are supplied as standard on all units:

- Main switch,
- A sequence relay that disables the power supply in the event that the phase sequence is incorrect (scroll compressors can be damaged if they rotate in the wrong direction),
- Thermal overloads (protection of pumps and fans),
- Compressor fuses,
- Control circuit automatic breakers,
- Compressor contactors, fan contactors and pump contactors.
- The terminal board has volt free contacts for remote ON-OFF, and general alarm.

MICROPROCESSORS

All Amicus units are supplied as standard with microprocessor controls. The microprocessor controls the following functions:

- Control of the water temperature,
- Antifreeze protection,
- Compressor timing, compressor automatic starting sequence (For multiple compressors),
- Alarm reset.

The control panel is supplied with display showing all operational icons. The microprocessor is set for automatic defrost (when operating in severe ambient conditions).

The control also manages the:

- Anti-legionella program,
- The integration with other heating sources (electric heaters, boilers, solar panels etc.),
- The operation of a three port modulating valve (for diverting to DHW or heating) and both the heating circuit pump and the domestic hot water circuit pump.

If required (available as an option), the microprocessor can be configured in order for it to connect to a site BMS system thus enabling remote control and management. Lochinvar technical support department can discuss and evaluate, in conjunction with the customer, solutions using MODBUS protocols.

CONTROL AND PROTECTION DEVICES

All units are supplied with the following controls and protections:

- User water return temperature sensor,
- Antifreeze protection temperature sensor installed on users water output,
- Domestic hot water supply and return temperature sensors,
- High pressure manual reset, low pressure automatic reset,
- Compressor thermal protection,
- Air fan, thermal protection,
- Pressure transducer (used to optimize the defrost cycle and to adjust the fan speed depending on ambient conditions), flow switch.

CONDENSATE DISCHARGE DRIP TRAY WITH ANTIFREEZE HEATER

Installed under the finned heat exchanger, this is used to collect the condensate generated during the heating mode operation. It is fitted with trace heating to prevent ice formation in low ambient conditions.

ANTIFREEZE KIT

This kit, standard on all units, comprises a “self-heating” electric cable that is wrapped around the user and domestic hot water exchanger and the water circuit pipework. This device is controlled by the microprocessor.

USER WATER STRAINER

All units are supplied complete with water strainer installed on user hot water circuit. The water strainer is the first filtration and is indispensable for the protection of plate heat exchangers and piping. The device has a filtration degree of 400 µm and replaceable filter cartridge. The particular conformation to Y, allows the deposit of impurities on the bottom of the seat the filter-holder and therefore an easy maintenance of the filter itself.

USER FLOW SWITCH

A flow switch is installed as standard on all units. It will prevent the unit from operating if flow is lost in the system. It is a paddle type switch that utilises permanent magnets to determine the flow rate and thus enable or disable the unit operation.

6 ACCESSORIES

- **Rubber vibration dampers**
 - To be installed beneath the unit base and the ground to avoid the transmission of vibrations and noise to the building.
- **RS485 serial interface card ModBus protocol**
 - This controller card enables the controller to communicate with other devices on a BMS using Modbus protocol.
- **High efficiency E.C. axial fans**
 - High efficiency E.C. axial fans, supplied with brush-less DC electric motors electronically commutated (E.C. motors) provide the highest energy efficiency class (EFF1), according to the latest EU specifications, which results in a substantial reduction in energy consumption, increased ventilation and noise reduction thanks to the new ultra-efficient blade profiling. The fans are statically and dynamically balanced and supplied complete with a safety guard complying with the requirements of EN60335. The fans are installed using a special steel profiled beam, which minimises all vibrations and noise emitted. The nominal rotation speed is 700 rpm. All units are fitted with a pressure transducer.
- **H-Frame**
 - Frame for mounting unit on flat roof, comes complete with adjustable feet with built in vibration dampers.
- **Electronic soft starter**
 - The soft starter reduces the peak starting current down to maximum 40% of the nominal peak value. The device can only be installed in the factory prior to delivery of the unit.
- **Remote control panel**
 - This panel can be mounted up to 50m (maximum) from the unit and replicates all of the control functions. It is connected using a twin cable of 2.5mm² section.

7 WHAT IS EVI

EVI stands for “Economised Vapour Injection.” The technology involves injecting refrigerant vapour into the middle of the compression process, a procedure that significantly boosts capacity and efficiency. Each scroll compressor used in these units is similar to a two-stage compressor with built-in inter-stage cooling. The process begins when a portion of the condenser liquid is extracted and expanded through an expansion valve. The low temperature liquid/gas mixture produced is injected into a heat exchanger that operates as a sub cooler. Any liquid is evaporated and the vapour produced is superheated. The superheated vapour is then injected into an intermediate port in the scroll compressor. This cold vapour reduces the temperature of the compressed gas thus enabling the compressor to raise the pressure to levels (and temperatures) beyond that possible with a single stage scroll. The additional sub cooling of the main volume of liquid refrigerant increases the evaporator capacity. This compressor technology generates a larger pressure ratio between condensing and evaporating pressures, with significant performance improvement. Using this technology enables Amicus units to produce hot water up to 63°C and the ability to operate down to -20°C ambient temperature.

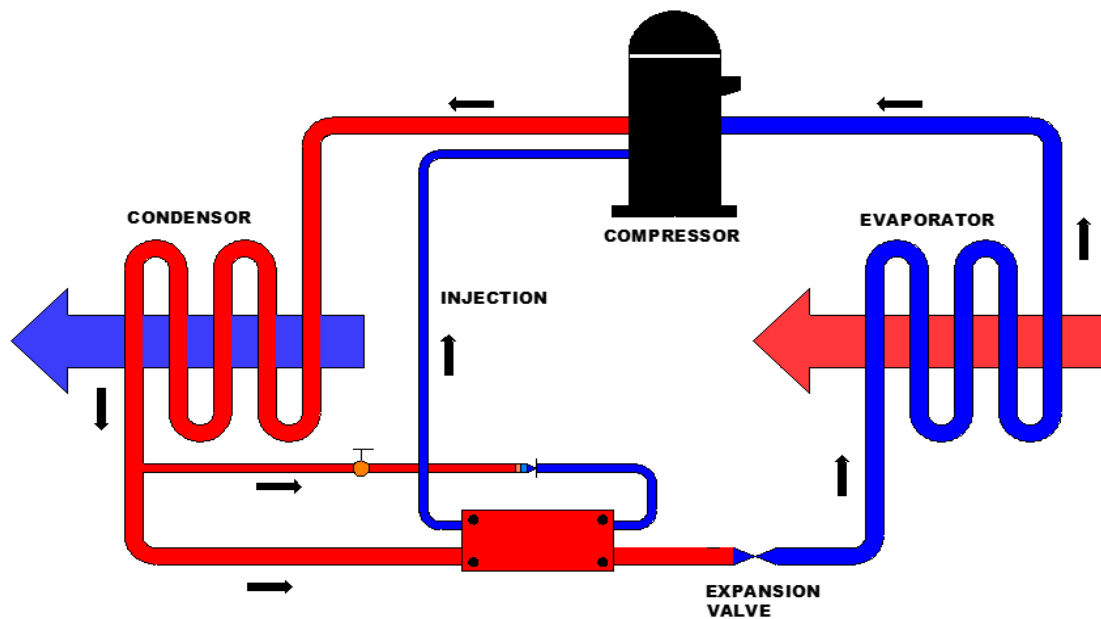

7.1.1 E.V.I FLOW DIAGRAM

The graph below shown the trend of the coefficient of performance (COP.) of a standard scroll compressor (Red line); with an EVI scroll compressor (Blue line).

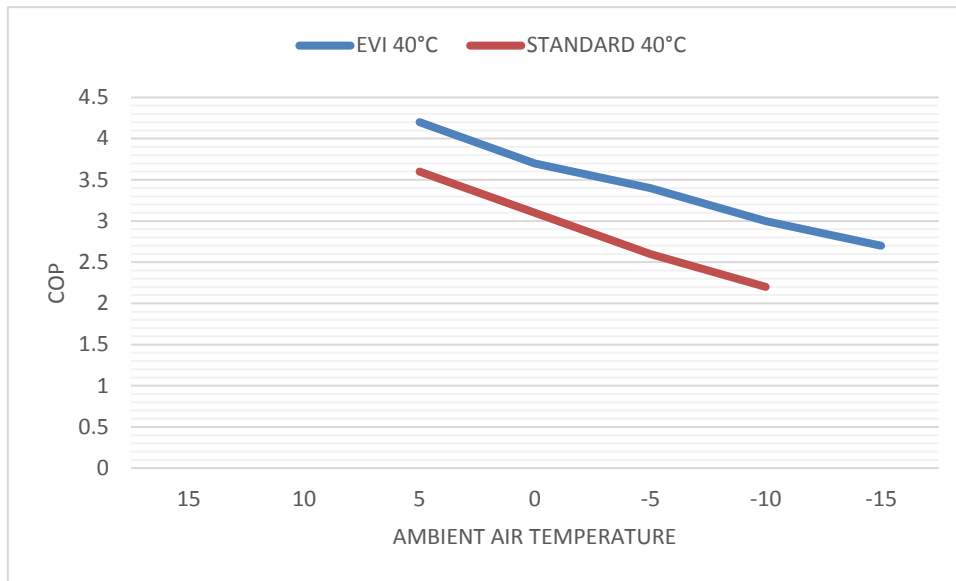

The efficiency of EVI compressors at low ambient conditions is about 25% higher than standard scroll compressors. The effect of this difference becomes even more evident in applications that require high hot water temperatures (i.e. when domestic hot water is required). In such applications, the operational limits of a standard scroll compressor prevent it from producing the required hot water temperature at air ambient temperatures below 5°C.

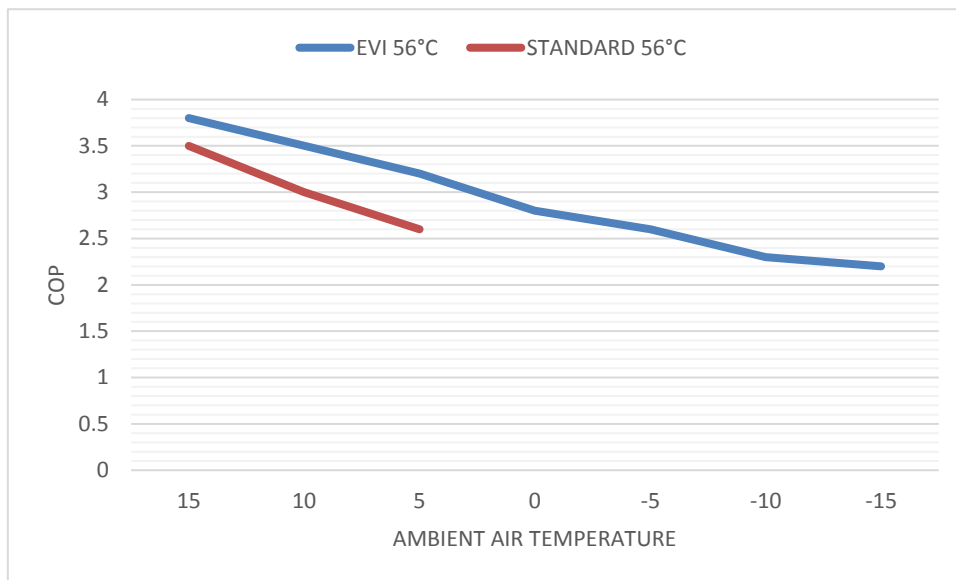

7.1.2 AMICUS OPERATIONAL LIMITS

The above chart shows the operational limits of the Amicus units fitted with EVI technology against the typical operation limits of a standard non EVI equipped Air Source heat pump. As can be seen the hot water outlet temperature remains much more stable giving useful heat output even at -20°C.

8 TECHNICAL DATA

TECHNICAL DATA TABLES

Data	Unit	Model												
		LAHP-8HT	LAHP-10HT	LAHP-15HT	LAHP-20HT	LAHP-252HT	LAHP-302HT	LAHP-452HT	LAHP-502HT	LAHP-602HT	LAHP-752HT	LAHP-852HT	LAHP-1002HT	LAHP-1202HT
Heating Capacity (EN14511) ¹	kW	7.7	9.6	15	19	24	30	41.2	49.2	57.4	65.6	79.9	87.2	100.7
Total Power input (EN14511) ¹	kW	1.8	2.3	3.4	4.5	5.2	6.8	9.2	11.8	12.9	15.1	17.8	19.4	23.5
COP (EN14511) ¹	W/W	4.28	4.17	4.41	4.22	4.64	4.39	4.49	4.16	4.57	4.35	4.49	4.49	4.29
EcoDesign data ²														
Energy Label Rating Low temperature		A++	A++	A++	A++	A++	A++	A++	A++	A++	A++	A++	A++	A++
SCOP Low Temperature		3.92	3.97	4.01	4.02	4.1	3.87	4	3.84	4.21	4.16	4.04	4.06	3.93
Seasonal Efficiency Low temperature	%	153.8	155.8	157.3	157.8	161	151.8	157.1	150.6	165.4	163.4	158.7	159.5	154
Energy Label Rating High temperature		A+	A+	A++	A++	A++	A+	A++	A++	A++	A++	A++	A++	A++
SCOP High Temperature		3.22	3.32	3.37	3.42	3.24	3.14	3.24	3.16	3.38	3.29	3.26	3.33	3.25
Seasonal Efficiency High temperature	%	125.6	129.8	131.6	133.8	126.5	122.7	126.6	123.4	132	128.6	127.3	130	126.9
General data														
Refrigerant		R410A	R410A	R410A	R410A	R410A	R410A	R410A	R410A	R410A	R410A	R410A	R410A	R410A
Power supply	V/Ph/Hz	230/1/50			400/3+N/50									
Maximum input current standard unit	A	17.1	17.1	15	15	20.6	24	34.2	39.4	44.2	54.2	67.6	68.6	77.4
Peak input current standard unit	A	17.1	17.1	15	15	62.9	83.1	119	149	141	168	209	210	208
Fans	n°	1	1	2	2	2	2	2	2	2	2	2	2	2
Compressors/refrigerant circuits	n°	1 E.V.I. DC inverter				2/1	2/1	2/1	2/1	2/1	2/1	2/1	2/1	2/1
Sound power level ²	dB(A)	65	65	67	67	70	72	73	74	73	73	74	75	75
Nominal flow rate	L/sec	0.39	0.41	0.76	0.87	1.14	1.43	2.03	2.39	2.83	3.33	3.95	4.25	4.89
Minimum water content in the user circuit	litre	100	100	200	200	240	300	412	492	574	656	799	872	1007
Sound pressure level ³	dB(A)	33.6	33.6	35.5	35.5	38	40	41	42	41	41	42	43	43
Dimensions														
Height	mm	1251	1251	1450	1450	1466	1466	1676	1676	1839	1839	1892	1892	1892
Length	mm	1208	1208	1402	1402	1915	1915	2115	2115	2905	2905	2905	2905	2905
Width	mm	650	650	650	650	875	875	875	875	1146	1146	1145	1145	1145
Weight	Kg	180	180	270	270	570	590	720	730	1080	1090	1140	1170	1250

- 1) 1=external air+7C 30/35 flow
- 2) 2=average conditions according to EU/811/2013
- 3) Sound pressure level at 10mtr from the unit in free field conditions direction factor Q=2 to ISO 9614

DIMENSIONS AND WEIGHTS

Legend	Data	Unit	Model										
			LAHP-8/10HT	LAHP-15/20HT	LAHP-252HT	LAHP-302HT	LAHP-452HT	LAHP-502HT	LAHP-602HT	LAHP-752HT	LAHP-852HT	LAHP-1002HT	LAHP-1202HT
A	Height	mm	1251	1450	1466	1466	1676	1676	1839	1839	1892	1892	1892
B	Length	mm	1208	1402	1915	1915	2115	2115	2905	2905	2905	2905	2905
C	Width	mm	650	650	875	875	875	875	1146	1146	1145	1145	1145
	Weight	Kg	180	270	570	590	720	730	1080	1090	1140	1170	1250

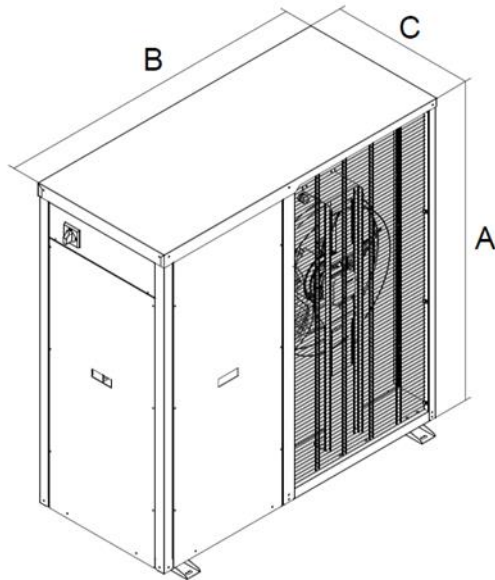

Models 8-20

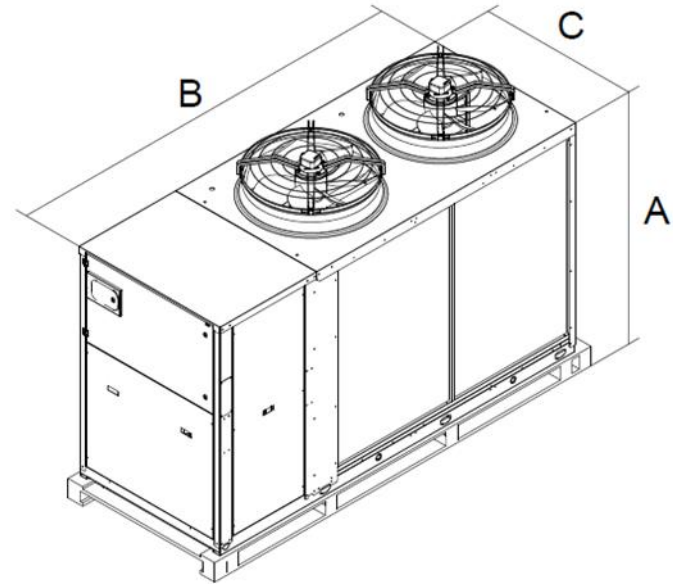

Models 252-1202

9 OPERATION LIMITS

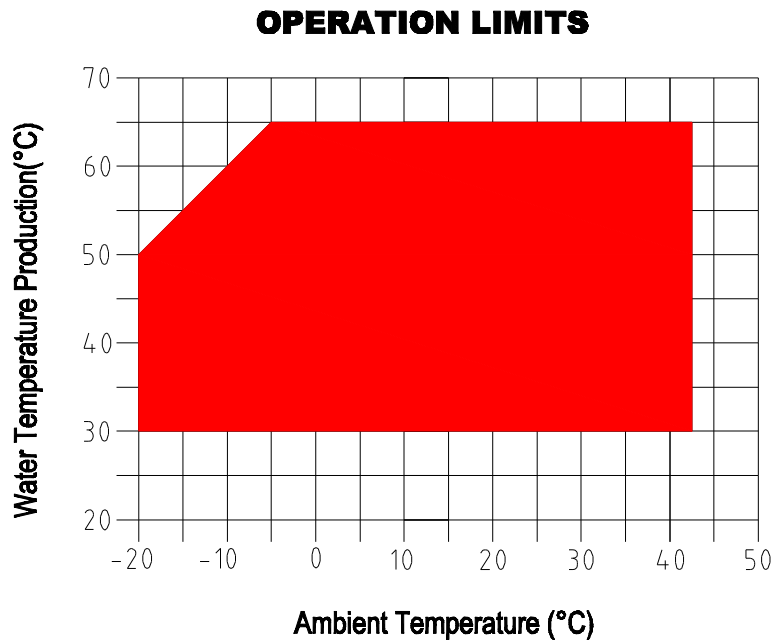

9.1.1 OPERATIONAL LIMITS OF THE AMICUS RANGE

HEAT EXCHANGER WATER PRESSURE DROPS

The nominal water flow rate given is referred to a Δt of 5°C. Maximum flow rate allowed is the one that presents a Δt of 3°C: higher values may cause too high-pressure drop. The minimum water flow rate allowed is the one presenting a Δt of 8°C. Insufficient values cause too low evaporating temperatures with the action of safety devices which would stop the unit. Unless given other information the nominal flow rate given in the technical data table should be used for pipe sizing etc.

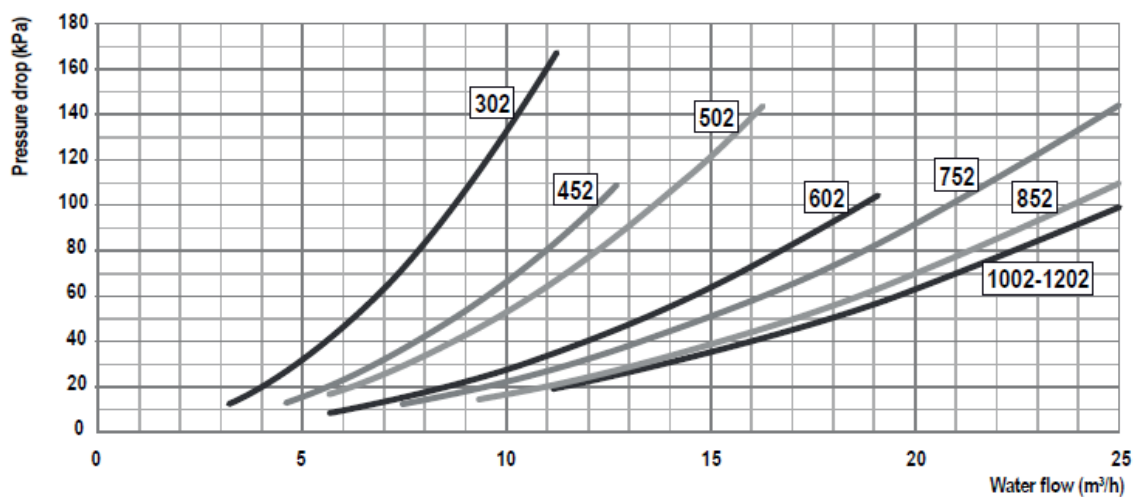

The above curve refers to plant which is clean and charged with water at 100%

USER HOT WATER TEMPERATURE

Once the system is on temperature, the minimum user water temperature should not be less than 30°C: Lower values could cause incorrect working operation of the compressor and compressor failure may occur. The maximum user outlet water temperature cannot exceed 65°C; higher values may call the action of safety devices that would stop the unit.

AMBIENT AIR TEMPERATURE

The units are designed and manufactured to operate in ambient air temperatures between -20°C to 43°C.



If the unit is installed in a very windy area, it will be necessary to install windbreaks to avoid potential problems. These need to be installed only if the wind speed is expected to exceed 2.5m/sec



The units are not suitable for installation in saline environments as supplied in their standard configuration



The units can be initially started with an external air temperature of -20°C and cold inlet water around 20°C. This is only allowed for a short period to bring the unit up to operating temperature. Installing a 3 way valve as a by-pass will reduce the operating time in such conditions.



Units are designed and manufactured to European safety and technical standards. These units have been designed exclusively for producing heating and domestic hot water only.

Lochinvar will not be liable for damage caused to persons, animal's material goods or property caused by incorrect use, maintenance or installation of the unit. Any use not specified in this manual is prohibited.



All units are supplied as standard with evaporating/condensing pressure control. This feature allows the unit to operate in heating mode at ambient temperatures above 15°C. The device monitors the evaporating/condensing pressure and maintains it at a constant level by modulating the airflow. It can also be used to reduce noise levels when ambient temperatures are lower i.e. at night.



Any operation outside the above parameters is not allowed.

10 DOMESTIC HOT WATER PRODUCTION

Amicus can produce domestic hot water either as a standalone system or by Pre-heating a gas fired water heater. It is important that any indirect cylinders used have been designed to work with Air source heat pumps, standard indirect cylinders will give poor performance and possible nuisance high pressure alarms with the Amicus unit. Only the solutions shown in this section should be used, further guidance can be obtained by contacting Lochinvar Ltd

SIZING INDIRECT CYLINDER COILS

Standard Indirect cylinders must not be used with Air Source Heat Pumps due to the sizing of the internal coil which are sized using typical gas boiler figures. We can calculate the kW output of an indirect coil using the formulae below:

1m² coil kW rating = Specific heat capacity water x flow/return temperature differential x flow rate (l/sec) or:

$Kw = 4.18 \times \text{flow/return DT} \times \text{flow rate (typical .33l/sec for gas boiler systems)}$

$4.18 \times 20 \times .33 = 27.58kw$

A typical 500 litre indirect cylinder requires 29kw to heat the contents in 1 hour, with a 1m² coil within it, the heat up time would be:

$29 \times 60 / 27.58 = 64.4 \text{ minutes}$

With a heat pump it is not possible to achieve the supply temperature or work at the large ΔT 's associated with fossil fuel boilers hence the output of a standard indirect coil would be substantially less than that calculated above. Special, enhanced surface area coils for use with smaller heat pumps (<20kW) and plate heat exchanger/buffer tank combinations for larger units should be used.

Both options are available from Lochinvar Limited.

Domestic Hot Water production drawings can be found in SECTION 11 Installation schematics

11 CORRECTION TABLES

OPERATION WITH GLYCOL

The water flow rate and pressure drop correction factors are to be applied directly to the values given for operation without glycol. The water flow rate correction factor is calculated in order to maintain the same temperature difference as that which would be obtained without glycol. The pressure drop correction factor takes into account the different flow rate obtained from the application of the flow rate correction factor.

Glycol %	Freezing point (°C)	CCF	IPCF	WFCF	PDCF
10	-3.2	0.985	1	1.02	1.08
20	-7.8	0.98	0.99	1.05	1.12
30	-14.1	0.97	0.98	1.09	1.22
40	-22.3	0.965	0.97	1.14	1.25
50	-33.8	0.955	0.965	1.2	1.33

CCF: Capacity correction factor
WFCF: Water flow correction factor

IPCF: Input power correction factor
PDCF: Pressure drop correction factor

Flow/return DT	3	5	8
Input power correction factor	0.99	1	1.01

11.1.1 CORRECTION TABLES DIFFERENT ΔT

Fouling factor	0.00005	0.0001	0.0002
Input power correction factor	1	0.98	0.95

11.1.2 CORRECTION TABLES DIFFERENT FOULING FACTORS

SOUND DATA

model	octave bands (hz)								lw		lp
	63	125	250	500	1k	2k	4k	8k	db	db(a)	db(a)
	db	db	db	db	db	db	db	db			
252	83.1	74.3	68.2	66.7	65.6	60.2	56.8	47.7	83.9	70.0	42.0
302	83.1	74.3	68.2	66.7	65.6	60.2	56.8	47.7	83.9	70.0	42.0
452	85.1	76.3	70.2	68.7	67.6	62.2	58.8	49.7	85.9	72.0	44.0
502	85.1	76.3	70.2	68.7	67.6	62.2	58.8	49.7	85.9	72.0	44.0
602	87.1	78.3	72.2	70.7	69.6	64.2	60.8	51.7	87.9	74.0	46.0
752	87.1	78.3	72.2	70.7	69.6	64.2	60.8	51.7	87.9	74.0	46.0
852	87.1	78.3	72.2	70.7	69.6	64.2	60.8	51.7	87.9	74.0	46.0
1002	92.1	83.3	77.2	75.7	74.6	69.2	65.8	56.7	92.9	79.0	51.0
1202	92.1	83.3	77.2	75.7	74.6	69.2	65.8	56.7	92.9	79.0	51.0

Lw: Sound power level according to ISO 9614

Lp: Sound pressure level measured at 10 metres from the unit in free field conditions direction factor Q=2 to ISO 9614

INSTALLATION

GENERAL SAFETY GUIDELINES AND THE USE OF SYMBOLS



All maintenance must be carried out by trained personnel and be in accordance with national and local regulations in force



The installation and maintenance of the unit must comply with local regulations in force at the time of the installation.



Avoid contact, do not insert any object into moving parts.

HEALTH AND SAFETY INFORMATION



The work area must be kept clean and clear of objects which could impede free movement. Appropriate workplace lighting should be provided.



Ensure the workplace is always adequately ventilated and that respirators are in good working order.

PPE



When installing or maintaining the unit the following protective equipment should be worn as required depending upon operation being performed as per local Health and Safety law



Protective footwear



Respirator



Eye protection



Hearing protection



Protective gloves

INSPECTION

During the installation or maintenance of the unit, the procedures and warnings within this document must be strictly followed at all times. On delivery, the unit must be checked for damage with any problems reported immediately to Lochinvar Customer service with supporting photographs, it is also important to mark the delivery paperwork accordingly before signing for acceptance.

BEFORE ACCEPTING THE UNIT CHECK:

- The unit did not suffer any damage during transport
- The delivered goods are conforming to that shown in the delivery note

IN CASE OF DAMAGE

- List the damage on the delivery note
- Inform Lochinvar Customer service of the extent of the damage within 24hours of receipt of the goods. After this time, any claim may not be considered.
- A full written report is required for cases of severe damage.

STORAGE

Units should be stored under cover and ideally, should remain in their packaging. The tools that are supplied for opening the electrics box should be formally transferred to the person responsible for the plant.

UNPACKING



Packaging could be dangerous for the installers

- It is advisable to leave units packaged during handling and remove it before the installation.
- The packaging must be removed carefully to prevent any possible damage to the machine.
- The materials constituting the packaging may be different in nature (wood, cardboard, nylon, etc.).



The packaging materials should be separated and sent for disposal or possible recycling via specialist waste companies.

LIFTING AND HANDLING

When unloading the unit, it is strongly recommended that sudden movements be avoided in order to protect the refrigerant circuit, copper tubes or any other unit component. Units can be lifted by using a forklift or, alternatively, using belts. Take care that the method of lifting does not damage the side panels or the cover. It is important to keep the unit horizontal at all time to avoid damage to the internal components.



The source fins are sharp wear suitable gloves when handling.

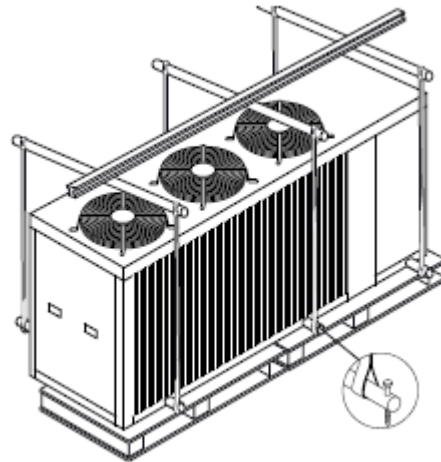
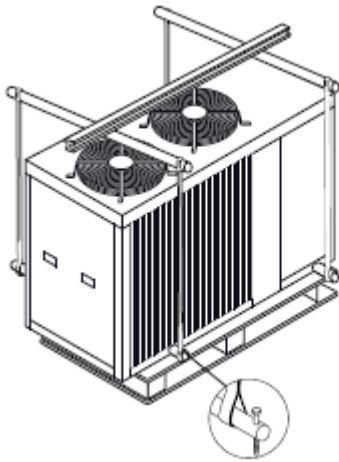

The unit must be installed in a location where access is available for maintenance and repair, the warranty does not cover the cost for access equipment or lifting equipment/cranes required to perform repairs during the warranty period.



The installation site should be chosen in accordance with EN378-1 and EN378-3 standards. When choosing the installation site all risks associated with accidental refrigerant leakage should be taken into account.

CLEARANCES

All units are designed for external installation: any overhang above the unit and location near trees, if they partially cover the unit, must be avoided in order to prevent air by-pass. It is advisable to create a proper mounting plinth, with a size similar to the unit footprint. Unit vibration level is very low: it is advisable however, to install vibration dampers (spring or rubber) between the plinth and the unit base-frame to keep vibrations at a very low level.(these are available as an ancillary item from Lochinvar or an alternative system would be to use a base system available from a company such as FRF systems <http://www.ussolutions.co.uk/dev/FRFSystemsSupportFeetBrochure.pdf>) It is vital to ensure adequate air volume to the source fan. Re-circulation of discharge air must be avoided; failure to observe this point will result in poor performance or activation of safety controls. For these reasons, it is necessary to observe the following clearances:

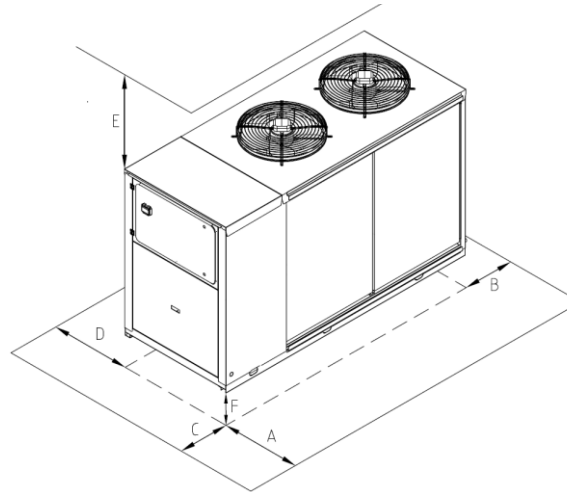

Legend	Unit	Model								
		LAHP-252HT	LAHP-302HT	LAHP-452HT	LAHP-502HT	LAHP-602HT	LAHP-752HT	LAHP-852HT	LAHP-1002HT	LAHP-1202HT
A	mm	1000	1000	1000	1000	2000	2000	2000	2000	2000
B	mm	800	800	800	800	1000	1000	1000	1000	1000
C	mm	800	800	800	800	2000	2000	2000	2000	2000
D	mm	800	800	800	1000	2000	2000	2000	2000	2000
E	mm	3000	3000	3000	3000	5000	5000	5000	5000	5000
F *	mm	350	350	350	350	350	350	350	350	350

*All Amicus Air Source Heat Pumps, during defrost mode, produce condensate at the base of the source heat exchanger. If the ambient temperature is below 0°C, the water may freeze, creating a thick layer of ice within the appliance. This layer of ice, in specific conditions, may damage the heat exchanger and therefore, to guarantee correct operation of the unit it is highly recommended to raise the Amicus ASHP by a minimum amount as shown in the table above.

INSTALLATION OF RUBBER VIBRATION DAMPERS

All units should be installed on vibration dampers in order to prevent the transmission of vibration to the supporting surface and reduce the noise level. Rubber vibration dampers are available as an option. The vibration dampers (optional) are supplied by the factory in separate packaging and will need to be fitted on site.

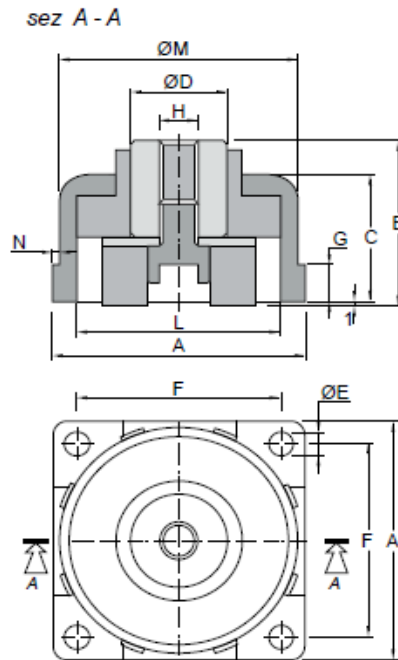

Model	A	B	C	ØD	ØE	F	G	H	I
LAHP252-302	65	48	36	30	6	52	8	M10	38
LAHP452-502	80	55	44	25	6.5	67	8	M12	41
LAHP602-1002	135	79	64	60	10.5	110	12	M14	25.5
LAHP1202	145	79	65	35	12.5	110	12	M16	118

SERIAL INTERFACE CARD-FACTORY FITTED

Supervision system interface serial board (MODBUS RS485 available only)

The installation of the card will allow the unit to be plugged in and connected to a system with MODBUS protocol. This system allows you to remotely monitor all the parameters of the unit and change their values.

The serial interface board is fitted at the factory. The supervision connectivity cable must be a telephone one type 2x0, 25-mm². The unit is configured at the factory with serial address 1. MODBUS RTU integration is available through the serial interface card, also BACnet at request.

CONDENSATE DRIP TRAY



In heating and domestic hot water mode, the unit can produce a quantity of condensate, depending upon the ambient conditions and the working hours. This condensate may freeze in severe ambient conditions. The unit must therefore be installed in such a way as to prevent a slipping hazard to the user or third parties due to the presence of ice around the heat pump.

All units are equipped with a condensate discharge tray positioned underneath the source heat exchanger (finned coil) and above the base frame; the drip tray is supplied with a self-heating antifreeze kit that melts the any ice present in the drip tray. The drip tray is supplied with a 3/4" male discharge connection that must be connected to a discharge pipe.

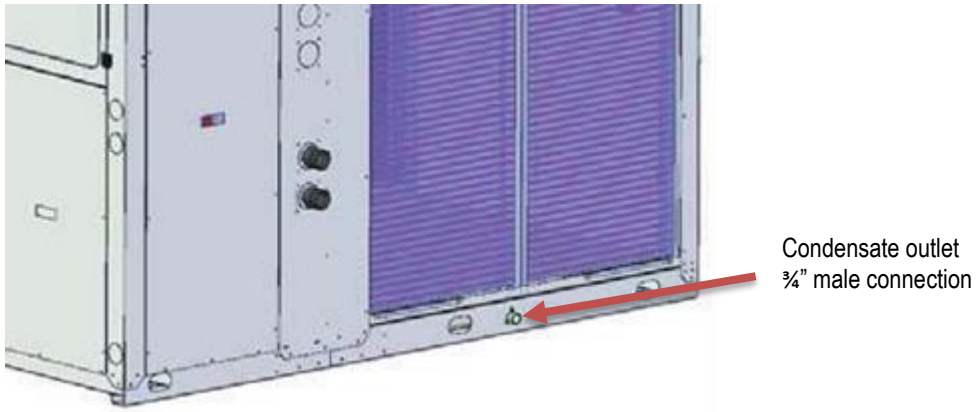

The condensate drain line should have a water trap, which may have minimum flying height equal to the suction of the fan, in any case never less than 35mm.

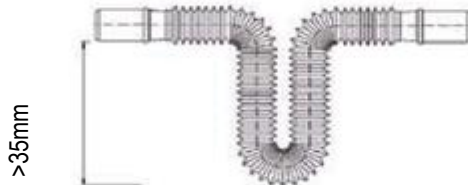

It is recommended that a heating cable be installed in the condensate drip tray discharge pipe to prevent freezing of the water inside the pipe itself, as this can lead to a malfunction of the unit.



The heating cable that is to be inserted in the discharge pipe must have a protection degree IP67 with a specific heating capacity of a minimum of 35w per linear metre. It is also recommended that the discharge pipe be insulated with closed cell type insulation having a minimum thickness of 15 mm.

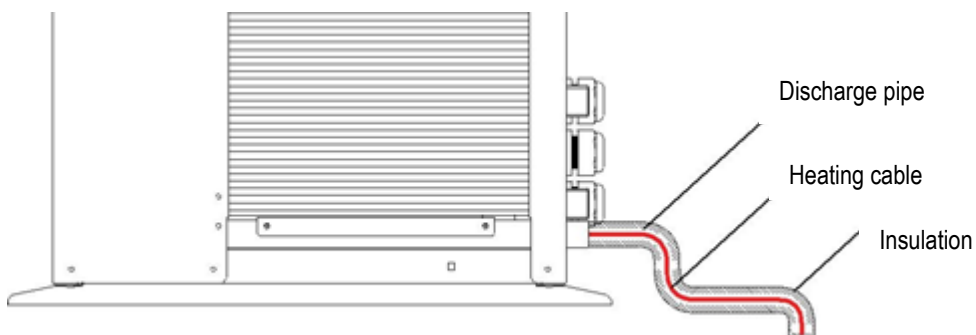

HYDRAULIC CONNECTIONS

The water pipe-work must be installed in accordance with national and local regulation and can be made from copper, steel, galvanized steel or PVC. The Pipework must be designed to cater for the nominal water flow and the hydraulic pressure drops of the system, a maximum pressure drop of 300 Pa/m run being typical. All pipes must be insulated with closed-cell material of adequate thickness. The hydraulic piping should include:

- Pockets for temperature sensors to measure the temperature in the system.
- Anti-Vibration Flexible joints, to isolate the unit from the rest of the system.
- Temperature and pressure gauges for maintenance and servicing operations.
- Manual Shut-off valves to isolate the unit from the hydraulic circuit.
- Metallic filters on the inlet pipe with a mesh not larger than 1 mm.
- Safety valves, A.A.V and a suitable filling point with a pressure make up unit, expansion vessel.



System return water must be fitted to the connection labelled: “user water in” as incorrect connection can damage the heat exchanger by freezing.



All amicus units are to be fitted with a filter on the water inlet with mesh no larger than 1mm. Fitting this filter is compulsory and the warranty will be invalidated if it is removed. The filter must be kept clean and checked periodically.



All units are factory supplied with a flow switch; the flow switch must be fitted in the pipework connection labelled “user water out”. If the flow switch is altered, removed, or the water filter omitted on the unit, the warranty will be invalidated.



**The water flow through the heat exchangers of the unit should not be fall below ΔT 8°C measured at the following conditions:
Heating mode: 7°C dry bulb ambient temperature, 35°C water outlet temperature;**

WATER QUALITY

The system is to be filled with clean water and vented after a full flushing operation has been performed; the water should have the following characteristics:

PH	6 -8	Total Hardness	Lower than 50ppm
Electric conductivity	Lower than 200mV/cm (25°C)	Sulphur ion	None
Chlorine ions	Lower than 50ppm	Ammonia ion	None
Sulphuric acid ions	Lower than 50ppm	Silicon ion	Lower than 30ppm
Total Iron	Lower than 0.3ppm		

HYDRAULIC COMPONENTS

All Amicus units can be supplied as standard with a Hydraulic kit comprising a suitable high efficiency pump and safety valve.

11.1.3 PIPEWORK CONNECTIONS

Inlet outlet connections are made using Victaulic® connections – details of the connection size can be found on the table below. The type and style of coupling shown can be used depending upon installation requirements, contact Victaulic® for more details. (<http://www.victaulic.com/en/products-services/products/?productCategory=18>) Lochinvar do not supply these fitting directly and will need to be purchased from your normal supplier.

Data	Unit	Model								
		LAHP-252HT	LAHP-302HT	LAHP-452HT	LAHP-502HT	LAHP-602HT	LAHP-752HT	LAHP-852HT	LAHP-1002HT	LAHP-1202HT
Inlet/Outlet connection size	Inch	1¼	1¼	1½	1½	1½	1½	1½	2	2



Standard Victaulic® Zero flex Rigid coupling
Style 07 1" to 12" Available



Standard Victaulic® Flexible coupling
Style 77 ¾" to 12" Available



QuickVic™ Victaulic® Rigid coupling
Style 107 2" to 8" Available

USER CIRCUIT (HEATING CIRCUIT) MINIMUM WATER CONTENT



Heat pumps need minimum water content inside the user circuit in order to guarantee the unit functions correctly. Correct water content reduces the n° of starts-and-stops of the compressors and this extends the operating life of the unit and allows a reduction of the hot water temperature during the defrosting cycle. The minimum recommended water content is between 10 and 20l/kW. Contact Lochinvar limited for further advice

Model	252	302	452	502	602	752	852	1002	1202
Minimum water content winter mode (liters)	250	300	400	500	600	700	800	1000	1200

DOMESTIC HOT WATER MINIMUM WATER CONTENT



The minimum domestic hot water circuit content shown in the above table shows the minimum water content required by the system to guarantee the correct operation of the unit in terms of the acceptable number of starts of the compressors and the minimum allowed working time per cycle. The values shown below do not guarantee the availability and temperature of domestic hot water; the correct volume must be calculated based upon the domestic hot water system type and on the user requirements. For further information, please contact Lochinvar limited.

Model	252	302	452	502	602	752	852	1002	1202
Minimum water content winter mode (liters)	250	300	400	500	600	700	800	1000	1200

If using a plate and buffer arrangement as shown in the schematic on solution 2 and solution 7 then the DHW vessel volume can be included within the minimum domestic hot water circuit calculation, however if using any indirect cylinder this cannot.

FILLING THE HYDRAULIC CIRCUIT

- Before filling, check that the installation drain valve is closed.
- Open all pipework, heat pump and terminal unit air vents.
- Open the shut off valves.
- Begin filling, slowly opening the water valve in the filling group outside the unit.
- When water begins to leak out of the terminal air vent valves, close them and continue filling until the pressure gauge indicates a pressure of 1.5 bars.

The installation should be filled to a pressure of between one and two bar. It is recommended that this operation be repeated after the unit has been operating for a number of hours (due to the presence of air bubbles in the system). The pressure of the installation should be checked regularly and if it drops below 1bar, the water content should be topped-up. If frequent top-ups are required, check all connections for leaks.

EMPTYING THE INSTALLATION

- Before emptying, place the mains switch in the "Off" position.
- Make sure the filling group valve is closed.
- Open the drainage valve outside the unit and all the installation and terminal air vent valves.



If the fluid in the circuit contains anti-freeze, it MUST not be allowed to run away to drain. It must be collected for possible re-cycling or for correct disposal.

TYPICAL INSTALLATION SCHEMATICS

Lochinvar Amicus Air source heat pumps are versatile units, which can be installed either as a standalone heat source or in conjunction with other technologies to provide a cost effective low carbon solution. The following pages show the 8 standard installation solutions recommended by Lochinvar when using the Amicus air source heat pumps. These solutions are intended to give a guide to a suitable installation but for installations outside these parameters please contact Lochinvar technical support where we would be able to help you ensure the system will work effectively and efficiently.

TPRV	Temperature and Pressure Relief Valve	AS	Air Separator
EV	Expansion Relief Valve	DS	Dirt Separator
EXV	Expansion Vessel	DV	Drain Valve
TD	Tundish	DCV	Double Check Valve
NRV	Non-Return Valve	FR	Flow Regulator
IV	Isolation Valve	3PV	Three Port Valve
LSV	Lock-shield Valve	2PV	Two Port Valve
PMP	Pump	AAV	Air Vent
HL	High Limit Stat	PHEX	Plate Heat Exchanger
TP	Temperature and Pressure Gauge	TS	Temperature Sensor
PRV	Pressure Reducing Valve	TS1	Heat Pump Return Sensor
AVC	Anti-Vibration Coupling	TS2	Heat Pump Flow Sensor
AVM	Anti-Vibration Mounts	BTI	User Circuit Sensor
SFG	System Fill Group	BTS	DHW Circuit Sensor
FSW	Flow Switch	STR	In Line Strainer

11.1.4 SOLUTIONS GUIDE LEGEND FOR DRAWINGS ON 11.1.5 TO 11.1.12



Lochinvar Ltd reserves the right to change specifications without prior notice. All necessary additional valves and fittings to be determined by those other than Lochinvar Ltd. Lochinvar Limited may provide technical advice and guidance to assist with best practice, optimisation and installation of Lochinvar products; however, we will not be liable for any duties as Designers under Construction (Design and Management Regulations 2015). In all cases where information is provided, the customer must assess and manage risks associated with the technical information and advice provided.

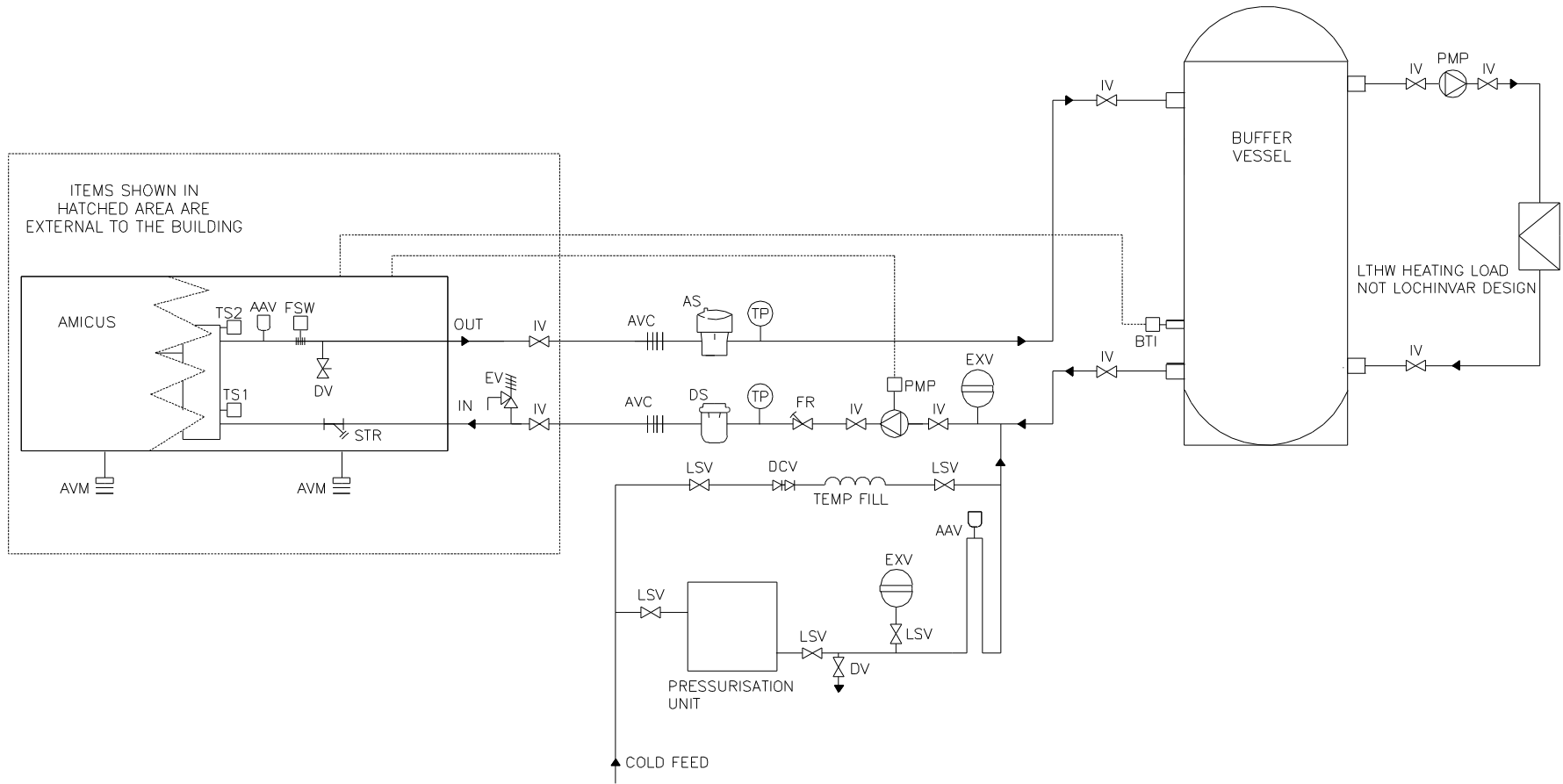

11.1.5 SOLUTION 1- AMICUS PROVIDING HEATING ONLY

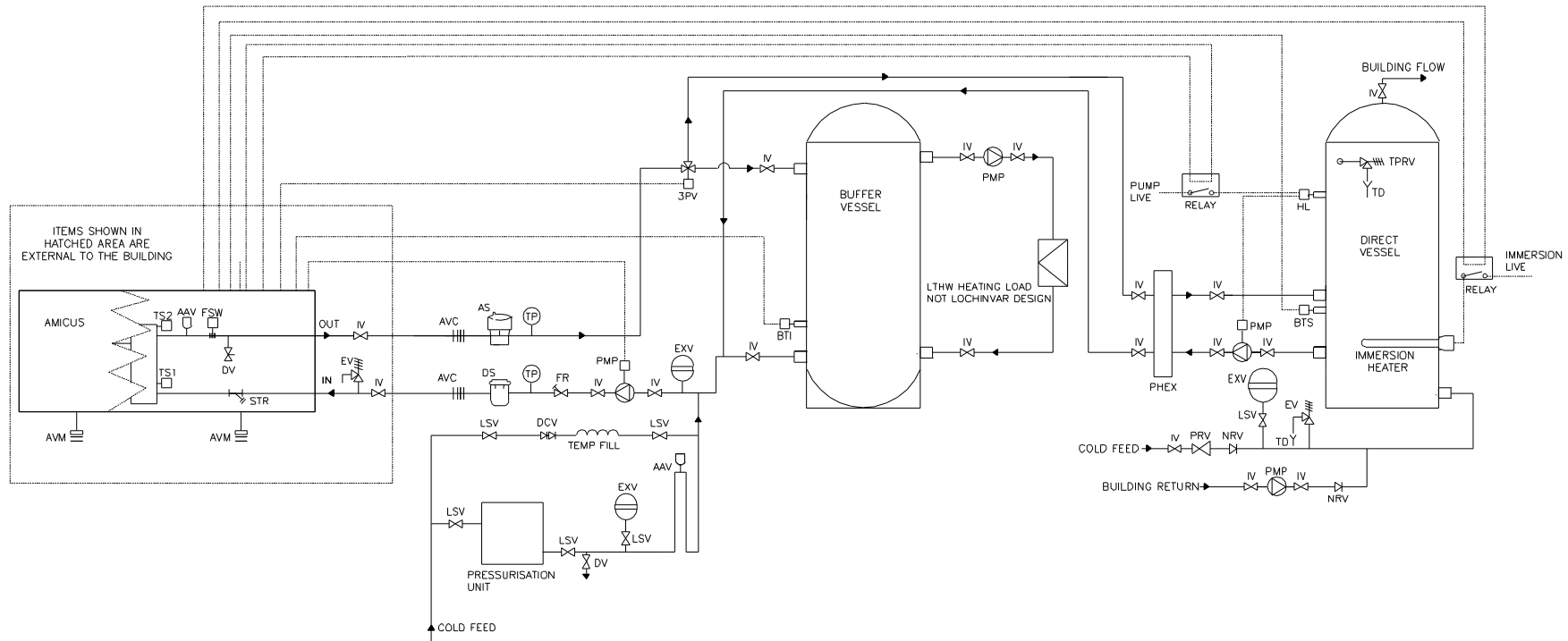

11.1.6 SOLUTION 2- AMICUS PROVIDING HEATING AND DOMESTIC HOT WATER VIA A PLATE AND BUFFER

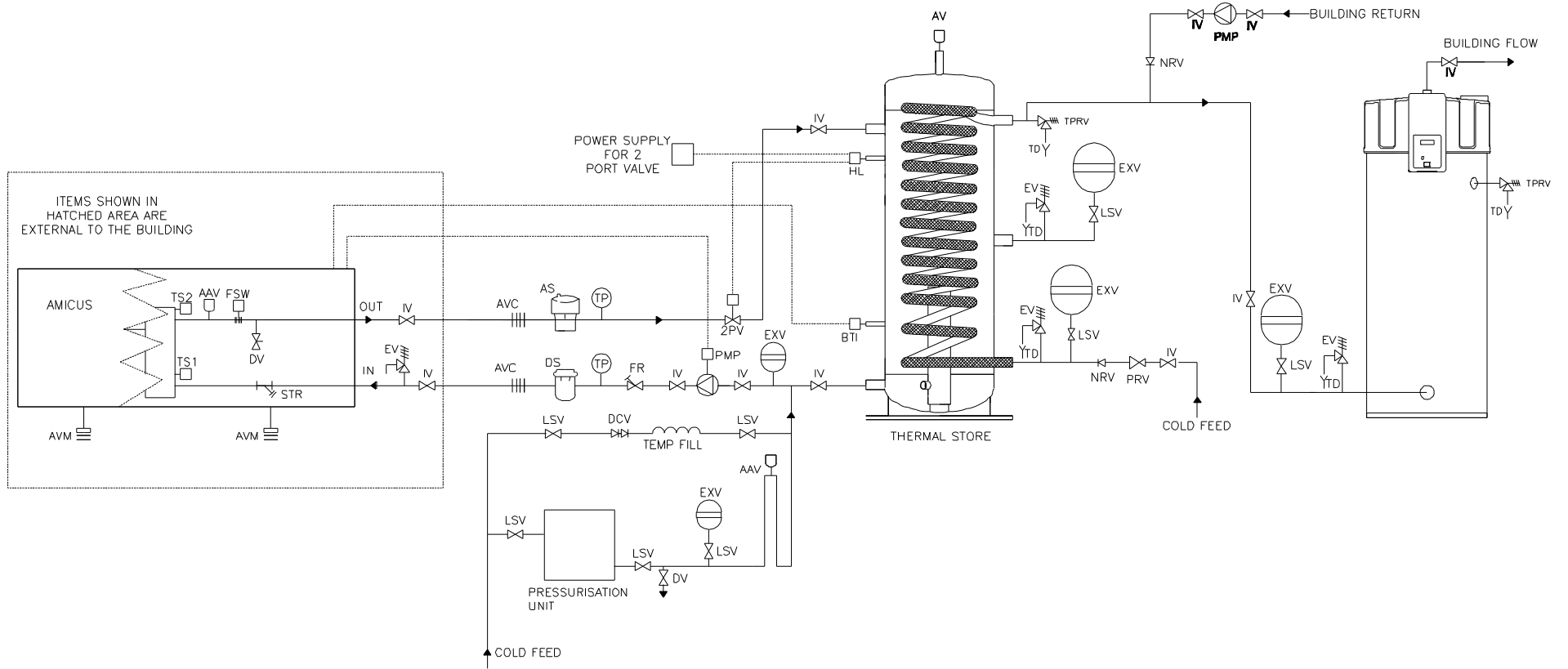

11.1.7 SOLUTION 3-AMICUS PROVIDING PRE-HEATED DOMESTIC HOT WATER TO A DIRECT GAS FIRED WATER HEATER VIA AN HSV THERMAL STORE

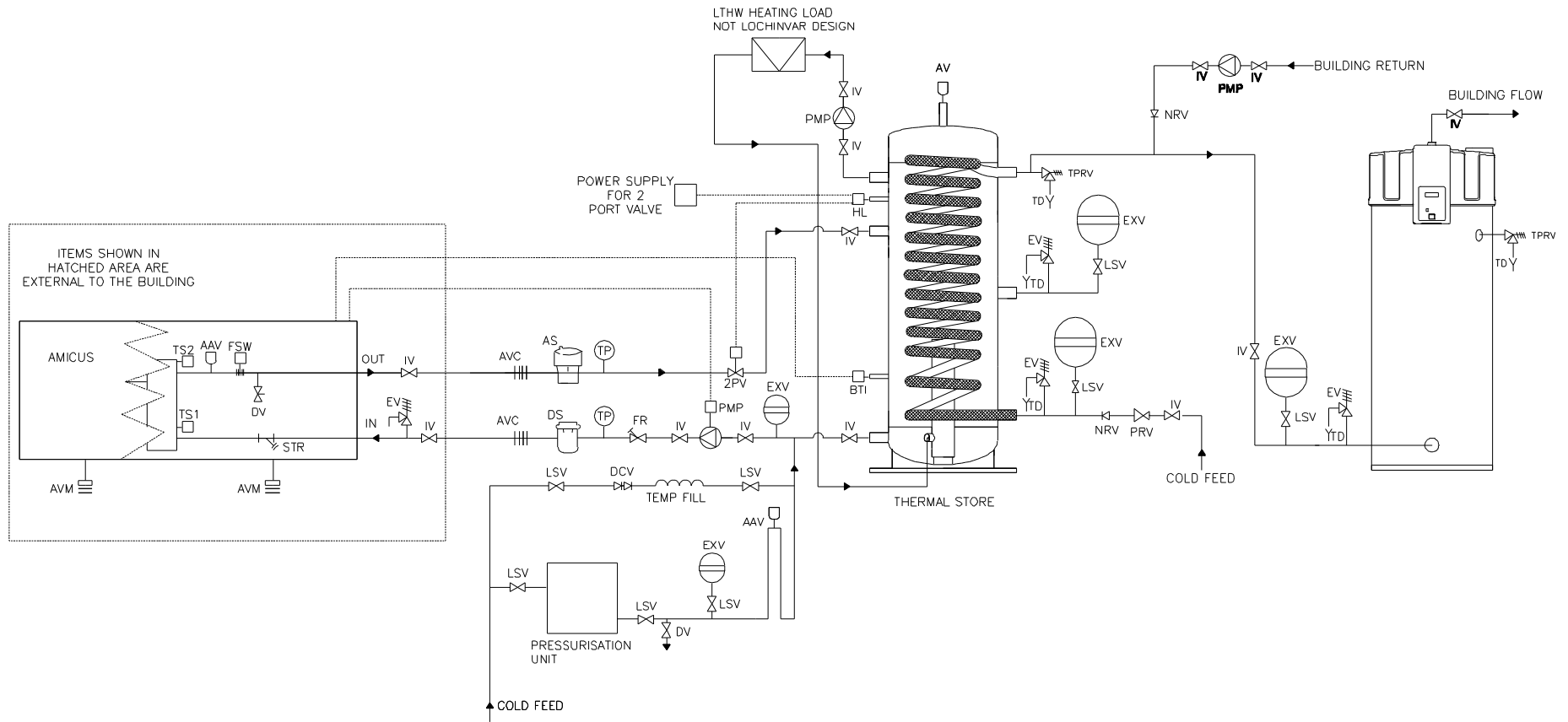

11.1.8 SOLUTION 4 – AMICUS PROVIDING HEATING AND PRE HEATED DOMESTIC HOT WATER TO A DIRECT GAS FIRED WATER HEATER VIA AN HSV THERMAL STORE

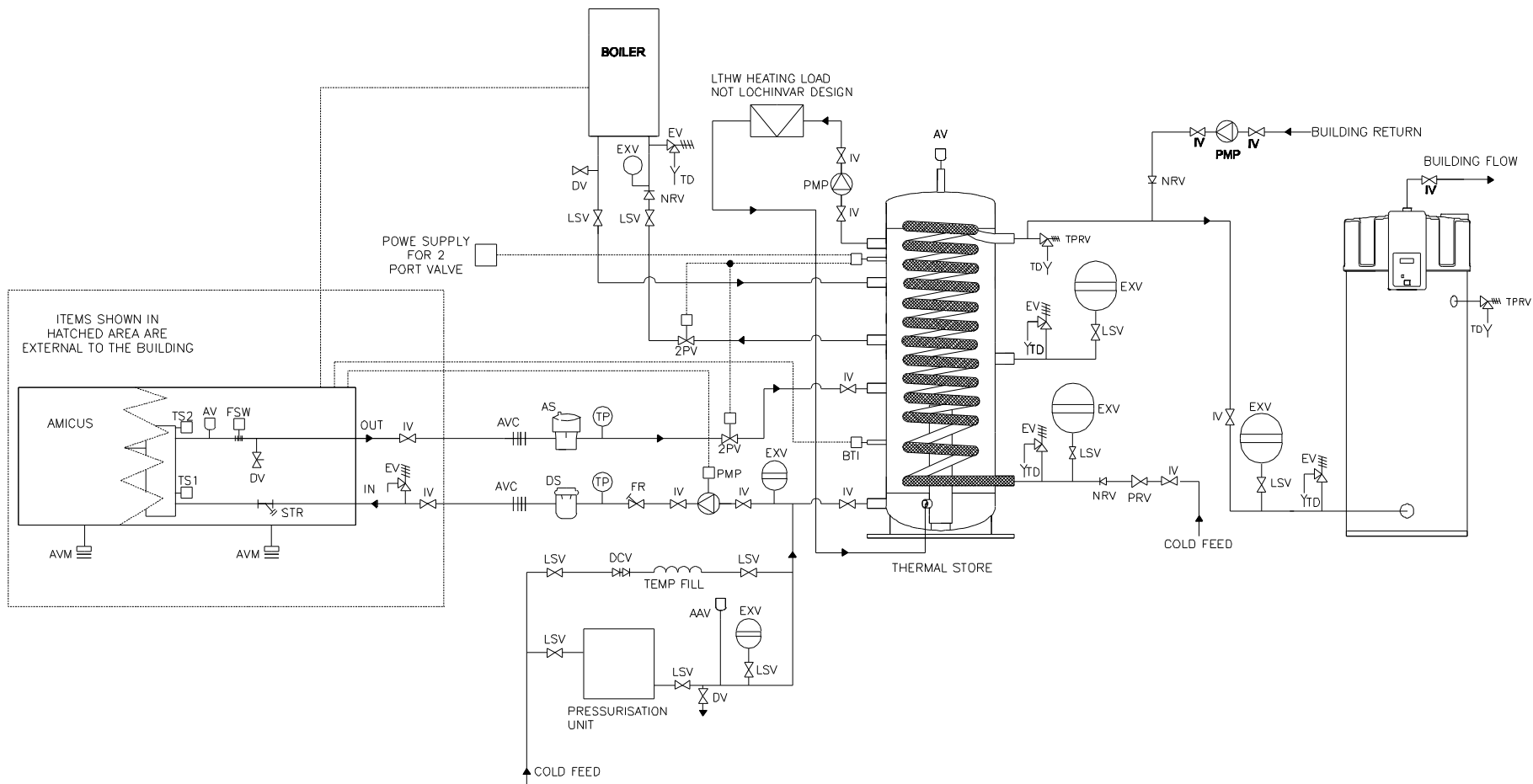

11.1.9 SOLUTION 5 – AMICUS PROVIDING HEATING AND PRE HEATED DOMESTIC HOT WATER TO A DIRECT GAS FIRED WATER HEATER VIA AN HSV THERMAL STORE WITH GAS CONDENSING BOILER SUPPORT

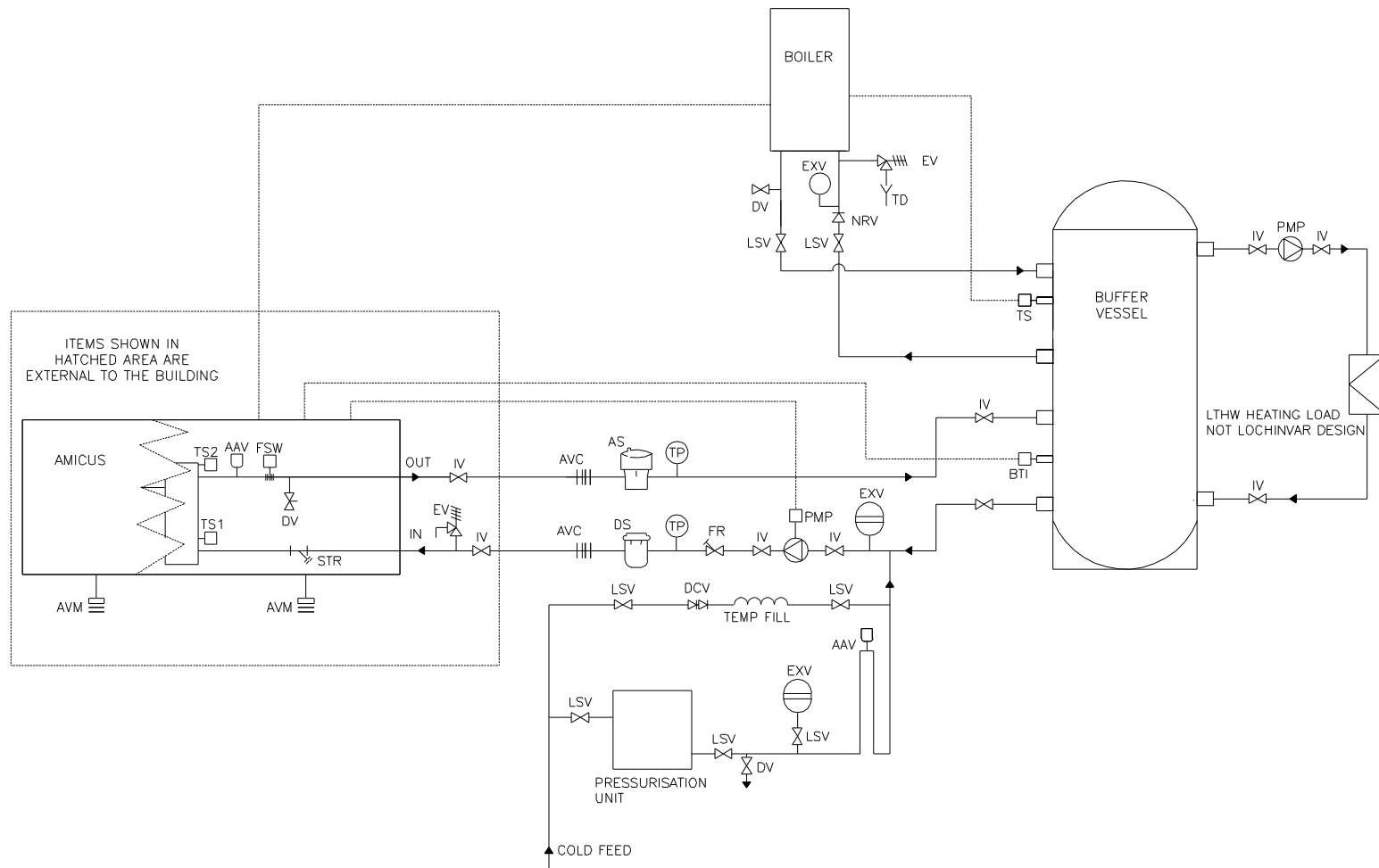

11.1.10 SOLUTION 6-AMICUS PROVIDING HEATING WITH GAS CONDENSING BOILER SUPPORT

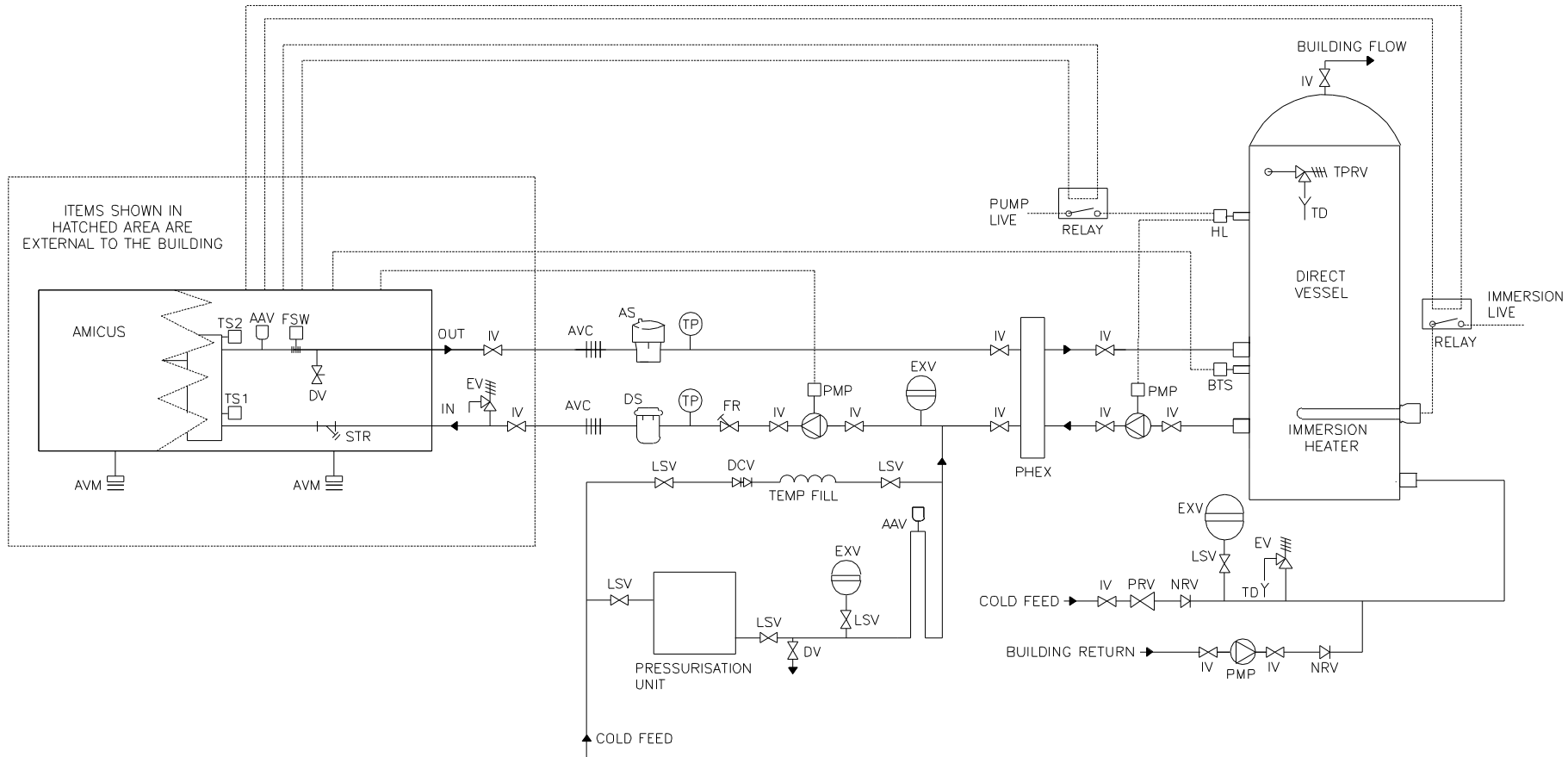

11.1.11 SOLUTION 7- AMICUS PROVIDING DOMESTIC HOT WATER ONLY VIA A PLATE AND BUFFER

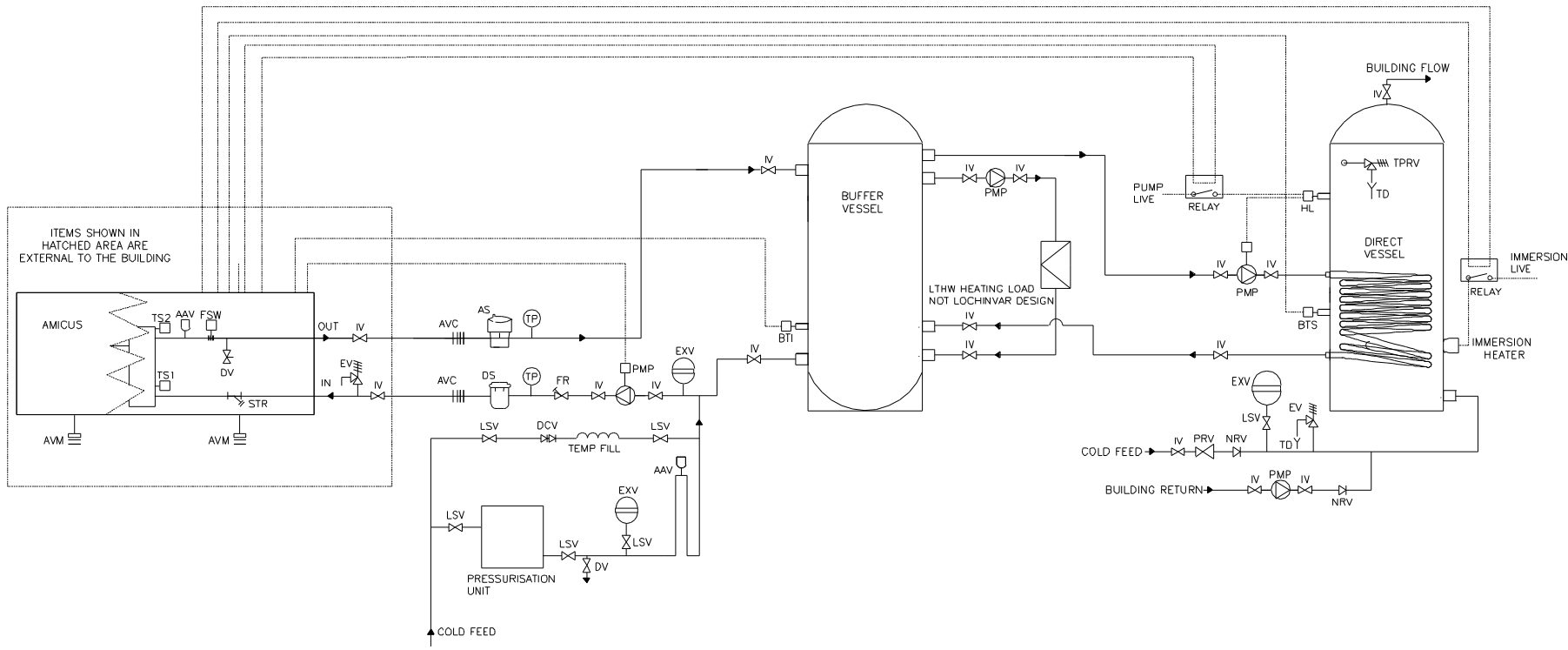

11.1.12 SOLUTION 8 – AMICUS PROVIDING HEATING AND DOMESTIC HOT WATER VIA AN INDIRECT CYLINDER SUITABLE FOR SMALL DHW LOADS ONLY

12 WIRING CONNECTIONS

The electric panel is located inside the unit at the top of the technical compartment where the various components of the refrigerant circuit are also found. To access the electrical board, remove the front panel of the unit:



Power connections must be made in accordance to the wiring diagram enclosed with the unit and with the regulations in force.



Make sure the power supply system upstream of the unit is isolated with a switch. Check that the switch handle is padlocked and there is a visible sign of warning not to operate.



It must be verified that the electrical supply corresponds with the specification shown on the unit-wiring diagram enclosed with the unit. IF IN DOUBT DO NOT SWITCH ON.



The power cable and line protection must be sized according to the specification shown on the wiring diagram supplied with the unit.



The cable selection must be commensurate with the calibration of the system side protection and must take account all the factors that may influence the selection such as temperature, type, length etc.



The power supply must respect the tolerances and limits shown in the document, any deviation will render the warranty invalid.



Flow switches must be connected to the unit. They must never be bridged out for any reason. The warranty will be invalidated if connections within the unit are altered or not properly made.



Make all earth connection as required by law.



Isolate the electrical supply and verify as such before carrying out any service work on the unit.



Frost protection will not operate if the main electrical switch is isolated, the switch should only be used to isolate the unit permanently and for service work.

ELECTRICAL DATA



The electrical data shown in the following tables refer to the standard unit without accessories. In all other cases refer to the data shown in the attached electrical wiring diagrams which are supplied with every Amicus unit.



The line voltage fluctuations cannot be more than $\pm 10\%$ of the nominal value, while the voltage unbalance between one phase and another cannot exceed 1%, according to EN60204. If these tolerances cannot be maintained, please contact Lochinvar Limited for advice.

Model		252	302	452	502	602	752	852	1002	1202
Power supply	V/~ /Hz	400/3+N/50								
Control board	V/~ /Hz	24 V	24 V	24 V	24 V	24 V	24 V	24 V	24 V	24 V
Auxiliary circuit	V/~ /Hz	230/1/50	230/1/50	230/1/50	230/1/50	230/1/50	230/1/50	230/1/50	230/1/50	230/1/50
Fans power supply	V/~ /Hz	230/1/50	230/1/50	400/3/50	400/3/50	400/3/50	400/3/50	400/3/50	400/3/50	230/1/50
Line section	mm ²	-	-	-	-	-	-	-	-	-
PE section	mm ²	-	-	-	-	-	-	-	-	-



Due to our continuous improvement process, electric data may change without notice. You should always refer to the wiring diagram supplied with the units.

ELECTRICAL CONNECTIONS

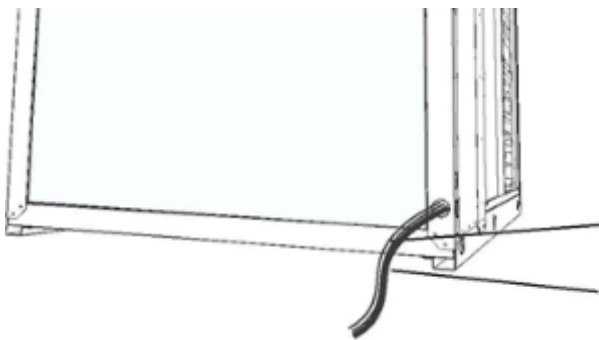

Due to our continuous improvement process, the numbering of internal connections may change without notice. You should always refer to the wiring diagram supplied with the units.

REMOTE WIRING CONNECTIONS (COMPULSORY)





All ancillary devices described below (pumps, valves, immersion heaters etc.) Must not be connected directly but should be switched using relays or contactors

All terminals referred to in the explanations below will be found on the terminal board inside the electrical box. All electric connections mentioned in the following tables are to be made by the installer, on site. The table below is for guidance only actual connections may vary on each model, please check wiring diagram supplied with each unit.

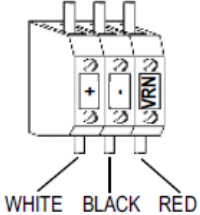
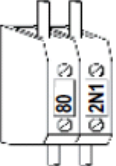

	<p>USER CIRCUIT WATER INLET SENSOR (BTI) It is used to measure the return water temperature from the user circuit. The sensor is connected to terminals 3 and 9. The standard working mode has the user pump switched off during stand-by periods (Compressors Off). The sensor must be placed in an appropriate position in order to measure the temperature of the secondary circuit (See 0). Incorrect positioning of the user water sensor can adversely affect the operation of the heat pump. The remote sensor is supplied loose with the unit (it is present inside the electric box) and it is supplied with a 3m cable length. If this is too short, it is possible to increase the length by using cable of diameter 0.5 mm² up to a maximum distance of 50m.</p>
	<p>USER CIRCUIT WATER PUMP If the pump is factory supplied and fitted within the unit it will already be connected otherwise, connect to terminals U7 and N7; maximum input current 3A. In standard configuration, the unit microprocessor controller switches off the user water pump when the set point is reached or if the unit is in standby. This strategy is suitable if the unit is heating a buffer store from which a secondary circuit is taken and provides a substantial reduction of energy use.</p>
	<p>DOMESTIC HOT WATER SENSOR (BTS) This is used to measure the return water temperature from the domestic hot water circuit. The sensor must be placed in the pocket provided in the DHW cylinder, in an appropriate position, in order to measure the correct temperature of the domestic hot water. (See 0). Incorrect positioning of the domestic hot water sensor can have an adverse effect on the operation of the heat pump. The sensor is supplied loose with the unit (it is placed inside the electric box) and it is supplied with a 3m cable length. The sensor is connected to terminals 6 and 9. If this is too short, it is possible to increase the length by using cable of diameter 0.5 mm², up to a maximum distance of 50m.</p>
	<p>DOMESTIC HOT WATER CIRCUIT PUMP To be connected across terminals U8 and N8; maximum input current 1A. In standard configuration, the microprocessor control of the unit switches off the user water pump when the set point has reached or if the unit is in standby. This strategy provides a substantial reduction of energy use. These terminals are used for the DHW shunt pump between the plate and buffer vessel when used.</p>
	<p>3 WAY ON/OFF VALVE The 3 way valve is used to produce domestic hot water; the valve is activated by the Domestic hot water sensor (BTS) and diverts the hot water either to the domestic hot water cylinder or to the user circuit. The valve is connected across terminals 2N1/68/69.</p>
	<p>REMOTE ON / OFF To switch the unit on or off remotely, the cable jumper connected across terminals 1 and 2 must be replaced with a switch. Contact closed, unit ON, Contact open, unit OFF.</p>
	<p>REMOTE GENERAL ALARM For remote display of a general alarm, connect the visual or audible device between terminals 90-91-92. Contacts 90/91 NC (Normally closed) Contacts 91/92 NO (Normally opened)</p>

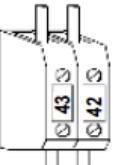
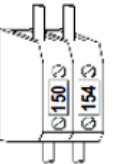
REMOTE WIRING CONNECTIONS (OPTIONAL)

	<p>REMOTE CONTROL PANEL</p> <p>The remote control panel replicates all of the functions on the main controller panel and can be remotely up to a maximum distance of 50 meters from the unit. The panel has to be connected to the unit by 2 wires having diameter 0.75 mm². The power supply cables must be separated from the remote control panel wires, in order to avoid interference. The control panel has to be connected to the terminals +, - and VRN. The control panel cannot be installed in an area subject to excessive vibration, corrosive gases, is a dirty environment or has a high humidity level. The ventilation openings must not be blocked.</p>
	<p>USER CIRCUIT INTEGRATION HEATERS</p> <p>If user circuit integration heaters are required, such as gas condensing boilers or electric heaters the coil of the contactor that is used to switch them must be connected across terminals 2N1 and 65.</p>
	<p>DOMESTIC HOT WATER ELECTRIC INTEGRATION HEATERS</p> <p>If domestic hot water circuit integration heaters are required, the coil of the contactor that is used to switch them must be connected across terminals 2N1 and 62.</p>
	<p>PRIORITY SELECTOR (Hot water)</p> <p>If a priority selector switch is to be fitted, a voltage free switch has to be connected to terminals 42 and 43. The selector operates as follows: Closed contact: Domestic hot water only; Opened contact: Domestic hot water / Heating The unit is supplied with nothing connected to terminals 42 and 43 (Open contact).</p>
	<p>HEATING CABLE</p> <p>This is used to prevent freezing of the condensate produced, in the outlet of the drain tray. The maximum current must not exceed 0.5 A relating to a maximum power of 100 W. It is connected to terminals 150 and 154 (this heating cable is operated in conjunction with the electric heater in the condensate drain tray).</p>

FACTORY FITTED WIRING CONNECTIONS

The table show standard factory supplied sensors that must be fitted to ensure the Amicus unit will perform correctly.

	<p>WEATHER COMPENSATED SENSOR (BTE)</p> <p>This is used to measure the ambient temperature enabling weather compensation modulation of the user set point with respect to the ambient conditions. It is connected to terminals 44 and 45.</p>
	<p>USER CIRCUIT WATER OUTLET SENSOR (BTO)</p> <p>This is used to measure the outlet user temperature; it is also used as antifreeze protection; it is connected to the terminals 5 and 9.</p>
	<p>USER CIRCUIT FLOW SWITCH (SFW1)</p> <p>This is used to protect the unit if there is a low water flow rate in the user circuit. It is factory fitted across terminals 43 and 35.</p>

POSITIONING OF THE USER CIRCUIT WATER SENSOR (BTI)

The correct positioning of the BTI sensor is extremely important to guarantee the correct operation of the heat pump. The BTI sensor is used to cycle the unit to maintain the user water temperature at set point. The BTI sensor is also used to activate the user water pump and to stop it when the user water temperature set point is reached. The BTI sensor **MUST** be positioned in order to measure the water temperature of the secondary circuit.



To guarantee the correct temperature measurements insert the probe in the sensor pocket of the buffer tank or DHW cylinder as shown in the schematics below.

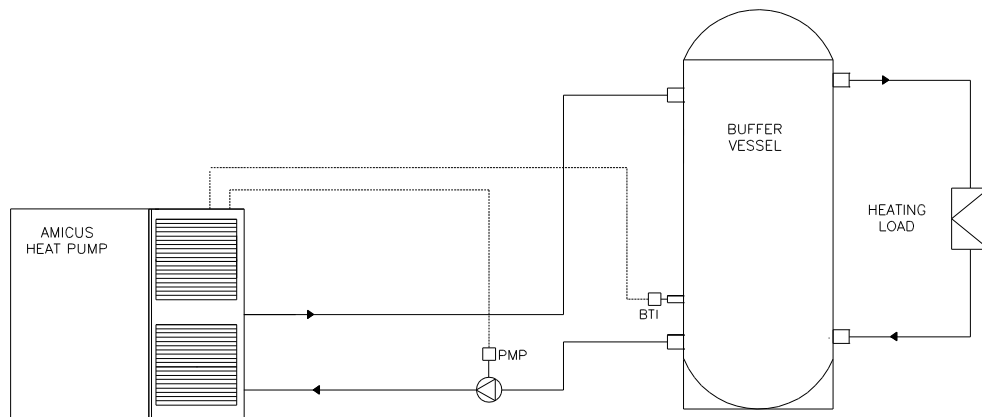

POSITIONING OF THE DOMESTIC HOT WATER SENSOR (BTS)

The correct positioning of the BTS sensor is extremely important to guarantee the correct operation of the heat pump in domestic hot water mode. The BTS sensor is also used to activate the shunt pump, back-up immersion heaters if required and controls the Pasteurisation programme.

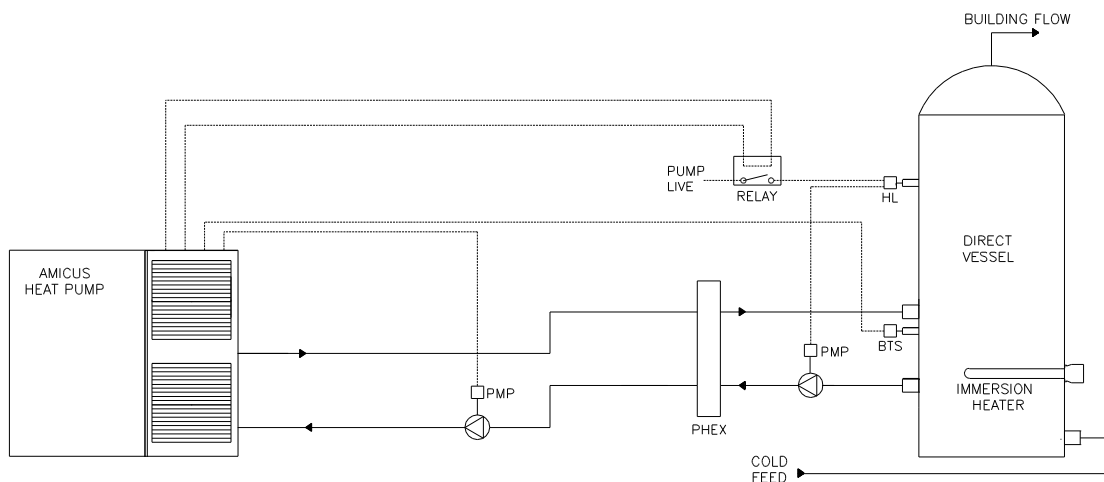

The sensor locations in an installation providing both heating and DHW can be found at solution 2, 7 and 8

REFRIGERANT CIRCUIT LAYOUT

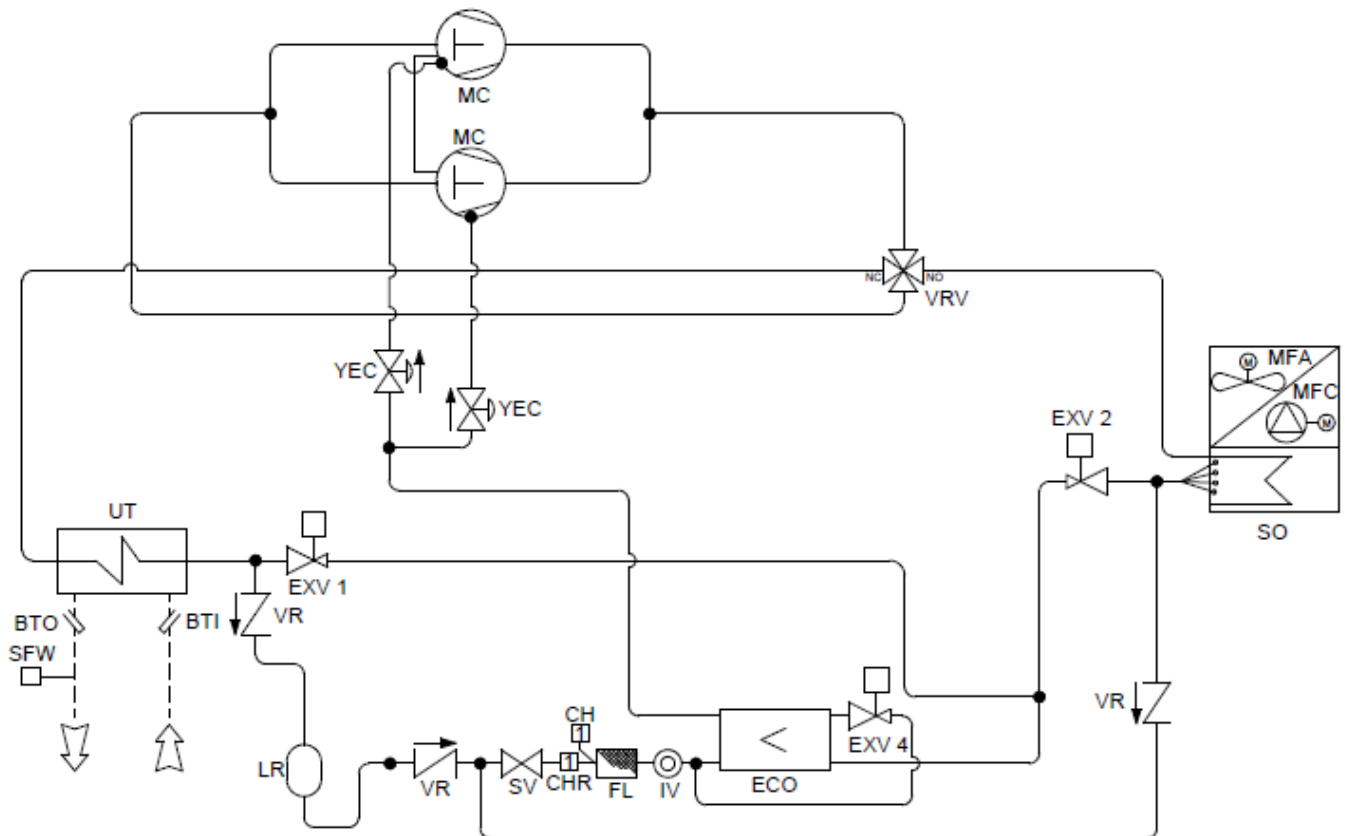

BTI	User water input probe	SFW	User flow switch
BTO	User water output probe	SO	Source side
ECO	Economizer	SV	Shut off valve
EXV	Thermostatic valve	UT	User side
FL	Liquid line filter	VR	Check valve
IV	Moisture indicator sight glass	YRV	Reverse cycle valve
LR	Liquid receiver	YEC	Economiser solenoid valve
MC	Compressor	----	Hydraulic connections
MFA	Source fan	Info	EXV3 not present in models 252 and 302



Amicus is a two-pipe air source heat pump that can, in addition to producing hot water for heating, also generate domestic hot water. The controller has dual heating set points (heating and DHW) and can control a three port diverting valve that directs the DHW to the cylinder. DHW production has priority.

13 UNIT START UP

PRELIMINARY CHECKS

Before starting the unit the checks detailed in this manual of the electric supply and connections **SECTION 12**, the hydraulic system **SECTION 11** and the refrigerant circuit **SECTION 12** , should be performed.



Start-up operations must be performed in accordance with the instructions detailed in the previous paragraphs.



If it is required to switch the unit on and off, never do this using the main isolator: this should only be used to disconnect the unit from the power supply when the unit is to be permanently off. Isolation will result in no supply for the crankcase heater and on start up the compressor could be seriously damaged.

BEFORE START-UP



Damage can occur during shipment or installation. It is recommended that a detailed check is made, before the installation of the unit, for possible refrigerant leakages caused by breakage of capillaries, pressure switch connections, tampering of the refrigerant pipework, vibration during transport or general abuse suffered by the unit.

- Verify that the unit is installed in a workmanlike manner and in accordance with the guidelines in this manual.
- Check that all power cables are properly connected and all terminals are correctly fixed.
- The operating voltage between phases R S T is the one shown on the unit labels.
- Check that the unit is connected to the system earth.
- Check that there is no refrigerant leakage.
- Check for oil stains, sign of a possible leak.
- Check that the refrigerant circuit shows the correct standing pressure on the pressure gauges (if present) otherwise use external ones.
- Check that the Schrader port caps are the correct type and are tightly closed.
- Check that crankcase heaters are powered correctly (if present).
- Check that all water connections are properly installed and all indications on unit labels are observed.
- The system must be flushed, filled and vented in order to eliminate any air.
- Check that the water temperatures are within the operation limits reported in the manual.
- Before start-up check that all panels are replaced in the proper position and locked with fastening screws.



Do not modify internal wiring of the unit, as this will immediately invalidate the warranty.



Crankcase heaters must be powered at least 12 hours before start up (pre-heating period) To do this, isolate the compressor(s), fans and pump(s) in the electrics box and then switch on the main isolator (heaters are automatically supplied when the main switch is closed). The crankcase heaters are working properly if, after several minutes, the compressor crankcase temperature is about 10÷15°C higher than ambient temperature.



During the 12 hours pre-heating period it is also important to check that the label OFF is shown on the display or that the unit is on stand-by mode. If there is an accidental start-up before the 12 hours pre-heating period has elapsed, the compressors could be seriously damaged and therefore the warranty will immediately terminate.

DEVICE SET-POINT DIFFERENTIAL RESET

Device		Set-point	Differential	Reset
Control thermostat (Heating mode)	°C	30	2	-----
Control thermostat (Domestic hot water mode)	°C	45	2	-----
Control thermostat	°C	23	2	-----
Anti-freeze thermostat	°C	4	4	Manual
High pressure switch	Bar	45	7	Automatic for 3 attempts then manual re-set
Low pressure switch	Bar	2	1.3	
Water safety valve (Present in A versions only)	Bar	6		Automatic



If the unit is required for, heating (without domestic hot water production) the internal parameter of the microprocessor fs1 has to be modified from 2 to 1 in order to avoid configuration alarms.

CONTROLS DURING UNIT OPERATION

- Check the rotation of the fans. If the rotation is incorrect, disconnect the main switch and change over any two phases of the incoming main supply to reverse motor rotation (only for units with three-phase fan motors).
- Check that the “user water inlet” temperature is close to the set point of the control thermostat.

REFRIGERANT CHARGE CHECKING

- After several hours of operation, check that the sight glass has a green colour core: if the core is yellow, moisture is present in the circuit. In this event, it is necessary for dehydration of the circuit to take place. Check that there are no continuous vapour bubbles present at the sight glass. This would indicate a shortage of refrigerant. A few vapour bubbles are acceptable.

14 CONTROL PANEL

POSITION OF THE CONTROL PANEL

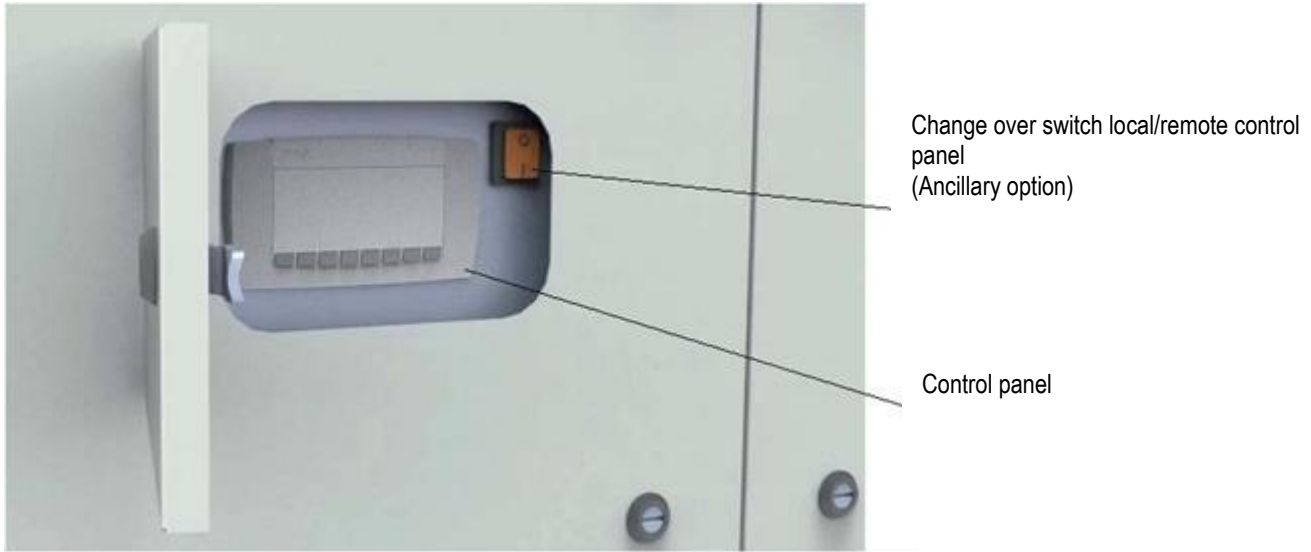

DISPLAY ICONS

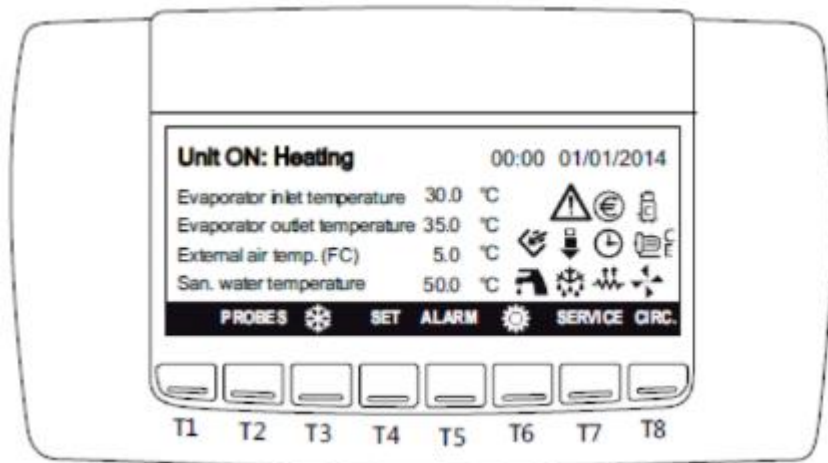

Icon	Meaning	Icon	Meaning
	Number of compressors in operation.		Indicates that the electric heaters are active.
	Water pump		Economy or ON/OFF by timetable.
	Indicates that the fans are working.		Free cooling is active (not available).
	Indicates that an alarm is active.		Domestic hot water.
	Economy function		Indicates that the defrost is active.
	Unloading function (not available).		

KEY FUNCTION

Key	Function	Description
T1		Not used
T2	PROBES	To view the value of configured probes
T3		Not used
T4	SET	To read and modify set point
T5	ALARM	Read and reset recent alarms
T6		To switch on the unit
T7	SERVICE	To enter service menu
T8	CIRC	Information on: compressor status, water pump status, pressure probe values

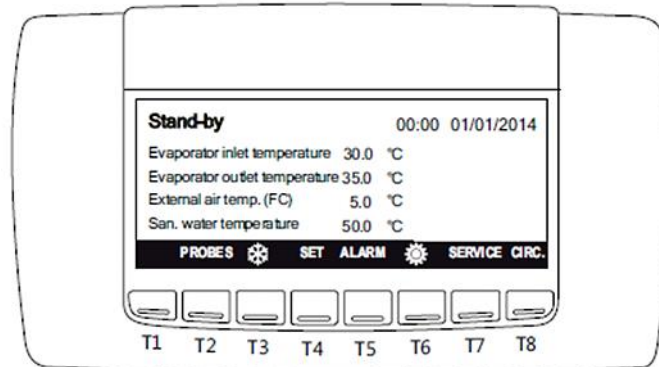

14.1.1 DISPLAY ON START UP

REMOTE CONTROL PANEL OPTION

To able the control from the remote panel, please operate on the switch near the panel of the unit, the arrow show the position of the switch. Note position of control panel may vary between model types.



SWITCHING THE UNIT ON

The unit can be switched on/off either:

- From the keyboard
- From digital input configured as remote ON/OFF

Switch the unit on from the keyboard

If requested, the compressor safety delay countdown starts and the compressor icon flashes. The water pump will be activated after few seconds and then, once the compressor countdown has finished, the compressor starts and the icon remains on. The display shows the user water inlet temperature and Domestic hot water inlet temperature.

14.1.2 HEATING MODE

To start the unit in heating mode, press the  key. The icon  appears on the display.

If requested, the compressor safety delay countdown starts and the compressor icon flashes. The water pump will be activated after few seconds and then, once the compressor countdown has finished, the compressor starts and the icon remains on. The display shows the user water inlet temperature and Domestic hot water inlet temperature.

14.1.3 DOMESTIC HOT WATER MODE

At the first start up, the unit microprocessor control checks the domestic hot water inlet temperature measured by the sensor BTS (this has priority over the other parameters) and, if the measured temperature is lower than the domestic hot water set point, it will activate the domestic hot water mode automatically. If the unit is required to operate in heating and the domestic hot water temperature is higher than the set point (there is no requirement for domestic hot water) the microprocessor control will activate the unit in heating mode. If the unit is required to operate in domestic hot water mode, the microprocessor control will activate both functions at the same time.

14.1.4 STANDBY MODE

In stand-by mode, the controller gives the possibility to:

- Display the set values
- Manage alarms, their display and reports.



If it becomes necessary to switch the unit off, never do this using the main isolator: this should only be used to disconnect the unit from the power supply when the unit is to be permanently off. Isolation will result in no supply for the crankcase heater and on start up the compressor could be seriously damaged.

14.1.5 HEATING

The display shows a typical visualization of a working unit:

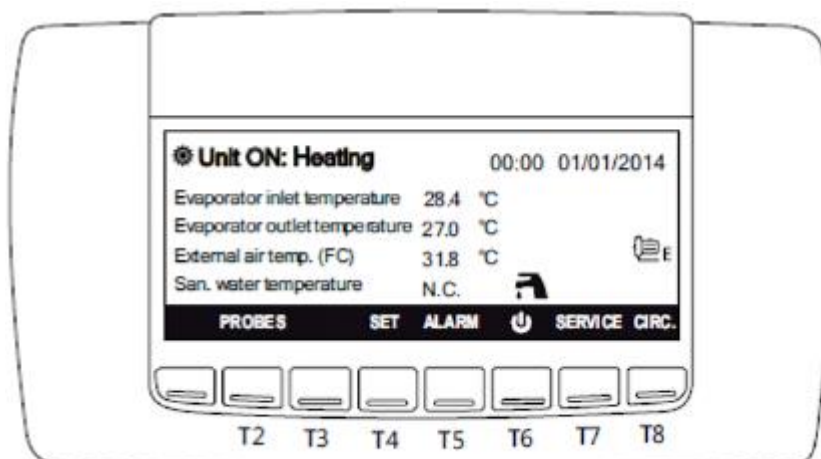

14.1.6 SWITCH THE UNIT ON FROM DIGITAL INPUT

If the unit is switched off by remote digital input, the display shows:

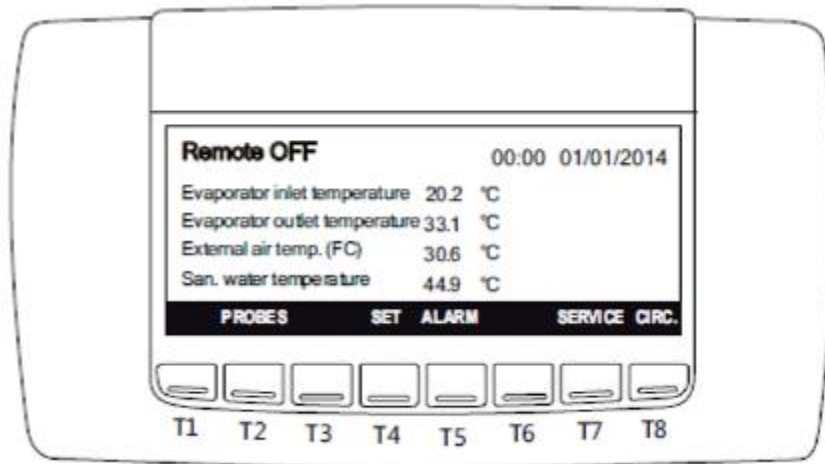

When the digital input is not active, the unit is in OFF mode

- The remote input has the priority with respect to the keyboard
- The unit can only be switched-on and off if the remote input is activated

14.1.7 STOP

To switch the unit off press the key 

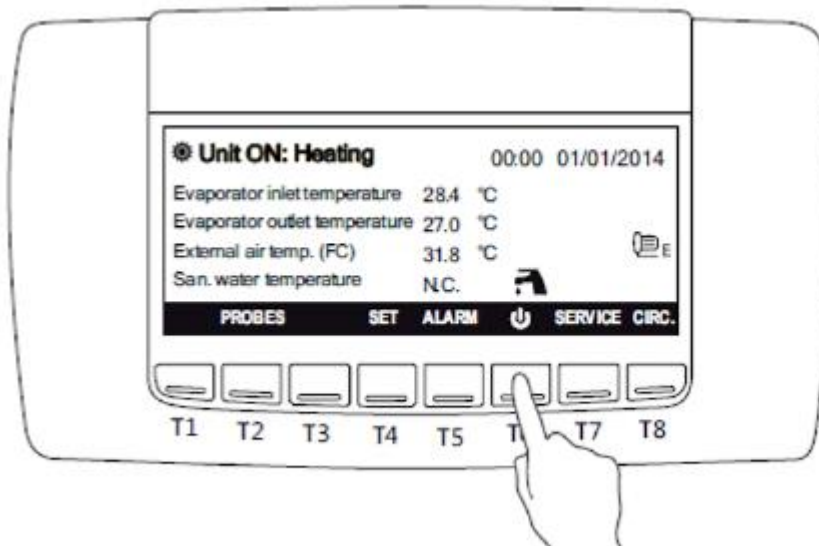

HOW TO CHANGE SET POINTS

To change the set point from the main screen, press SET.

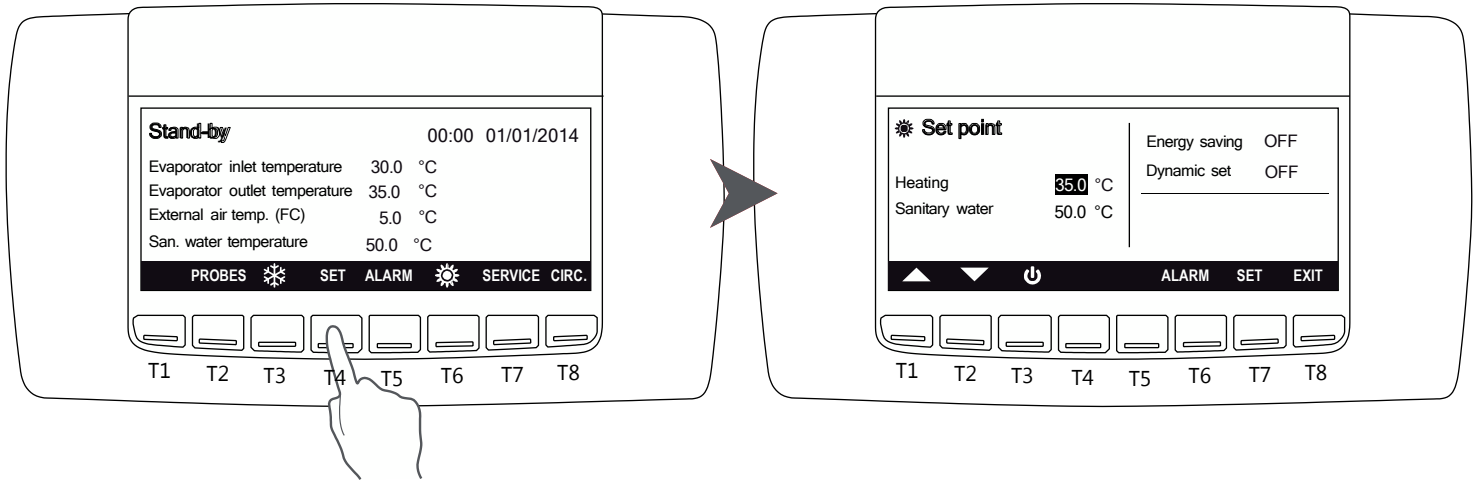

To modify the values, move the cursor with ; press **SET** to select, the value starts blinking, change the data pressing and . Once the required value is reached, press again **SET** to confirm.

The cursor will automatically position itself on the next value, to modify it, repeat the operation just described.

In this screen it is also possible to verify (but not modify) whether the energy saving mode and dynamic set are active.

Press **EXIT** to go back to the main menu.



All set points refer to the return temperature from the plant. For example if hot water at 45°C is requested and the Δt is 5°C, then the set point must be set at 40°C. If the Δt is 8°C, then the set point must be set at 37°C.

USER ADJUSTABLE PARAMETERS

The adjustable set points that can be modified by the end user are:

Function	Adjustment limit	Default value
Heating set-point	10÷55°C	35°C
Domestic hot water set-point	20÷55°C	50°C
Set point compensation	10÷25°C	23°C
Password	(Contact Lochinvar)	





The units are supplied with a very sophisticated control system with many other parameters that are not adjustable by the end user; these parameters are protected by a manufacturer password.

PROBES KEY

To view all the parameters measured by the sensors of the unit press

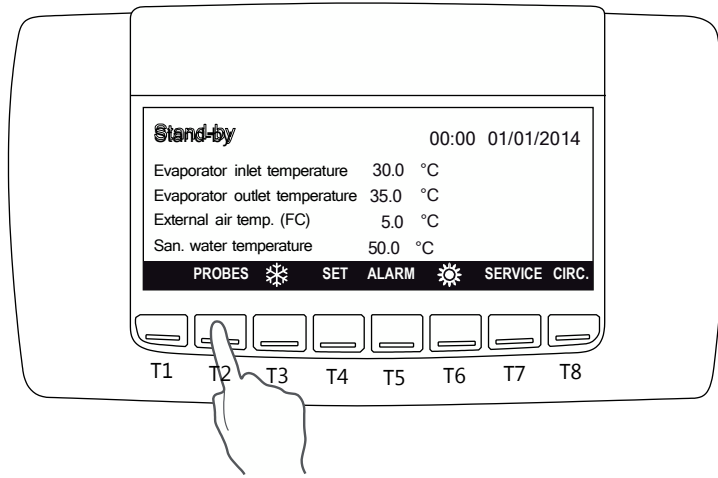
PROBES



By pressing the  key, all relevant values of the circuit will be displayed

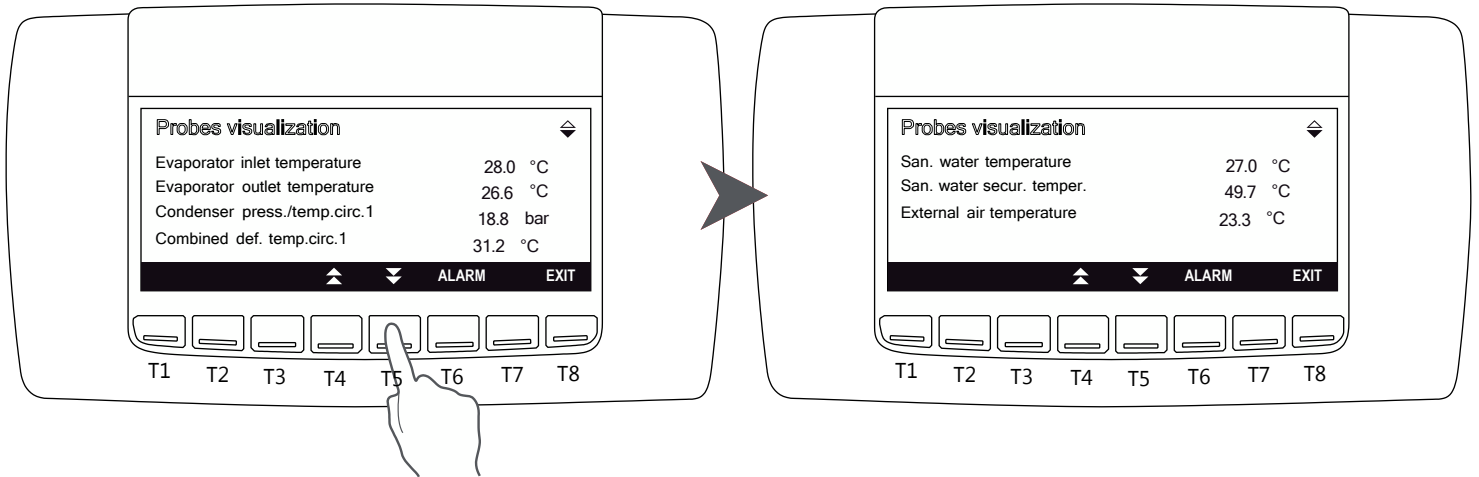

Press **EXIT** to go back to the main menu



ALARM KEY

When an alarm activates the display shows an  icon blinking.

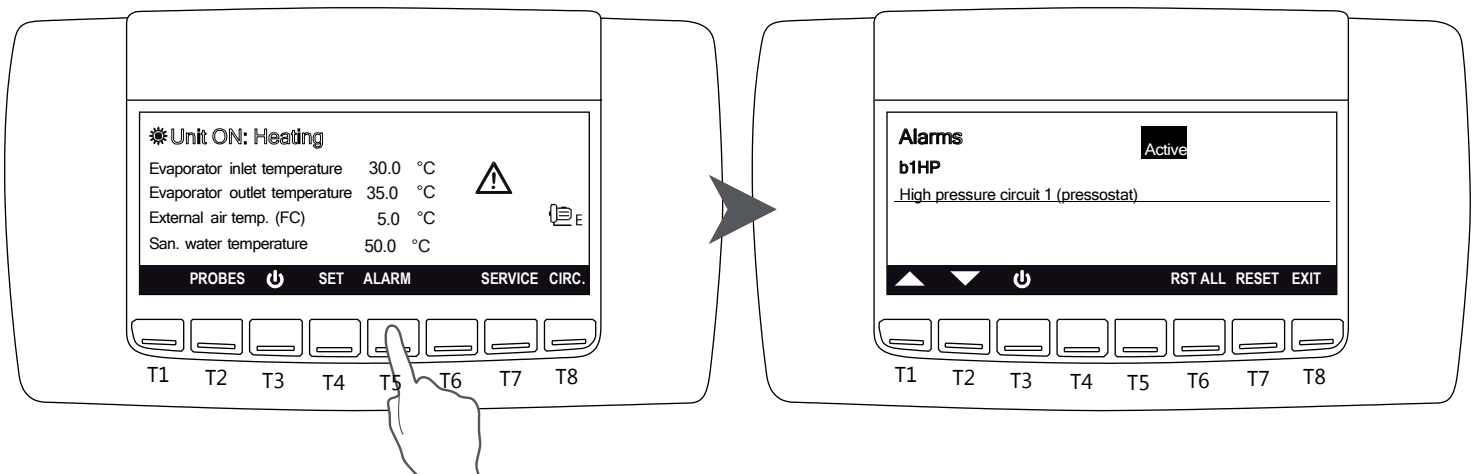
Press **ALARM** to read the alarm status.



The alarm status can be:

Reset: the alarm is not active and it is possible to reset it. Press  and  keys to select the alarm to select it and press **RESET** key to reset the alarm.

Password: In this case, the alarm is no longer active, but you need a password to reset it (please contact Lochinvar).





Active: the alarm is still active and it is not possible to reset it.

If more alarms that are resettable are present, it is possible to reset all of them at once pressing **RST ALL** key.

All the alarms remain present in the alarm history.

CIRC KEY

Pressing **CIRC** allows the viewing of the different parameters within the unit.

Pressing  and  you move from one screen to another while with  and  you scroll through the menu items. Press **ENTER** key to view values.

State of the compressors; the display shows compressors present in each circuit and the activation status of each one.

Colour black: compressor running

Colour white: compressor on standby

If the unit features screw compressors, an icon appears to the right of the compressor showing the level of step control.

If the unit features On/Off compressors (Scroll Type), no icon appears to the right of the compressor.

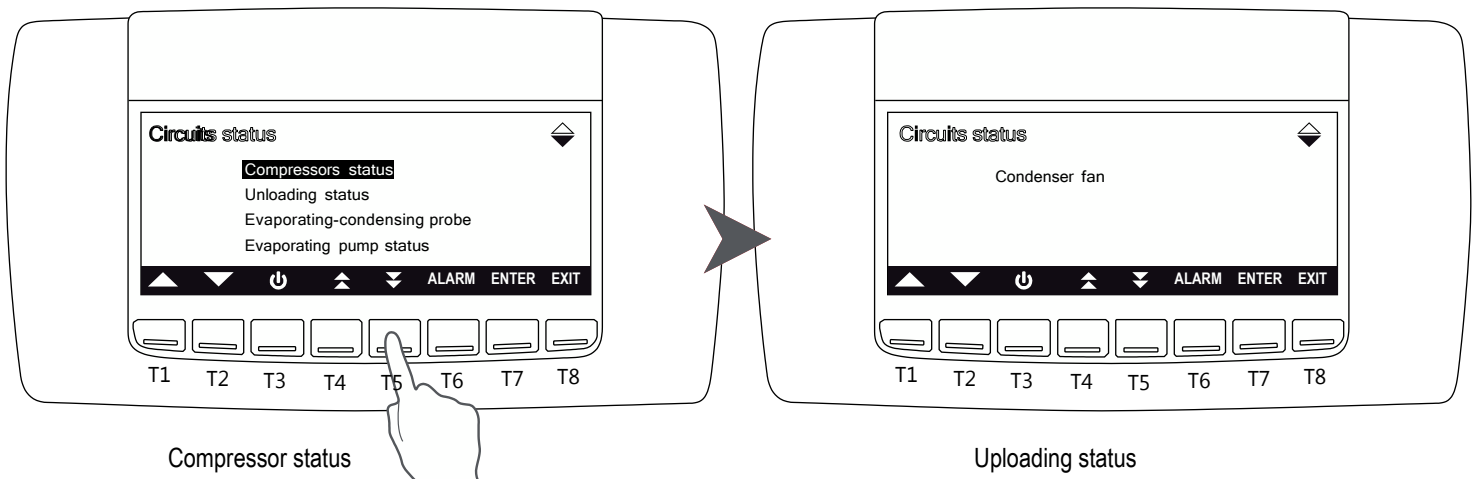
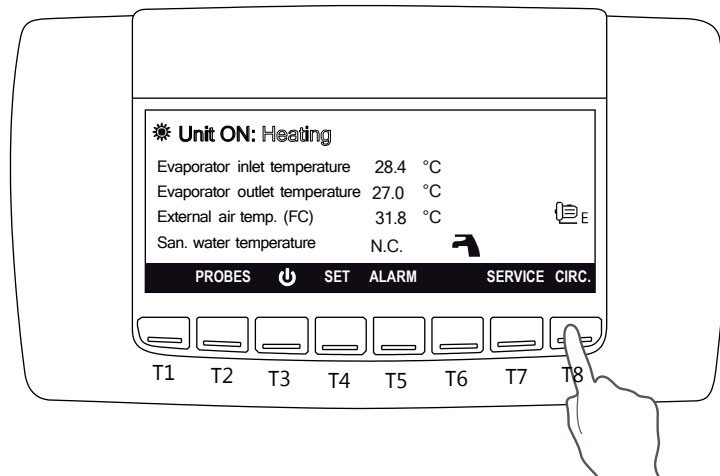

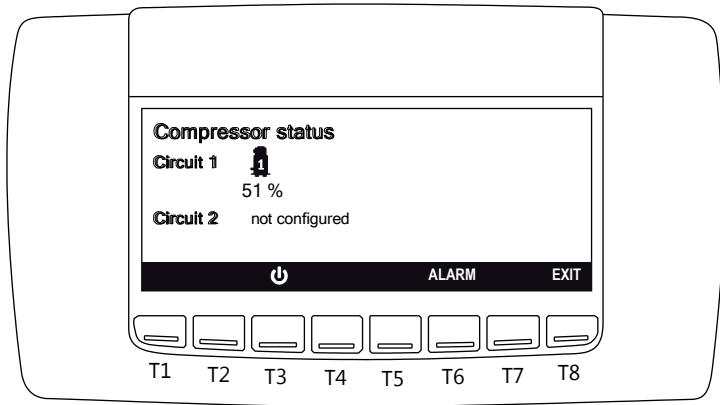

Evaporating-condensing probe

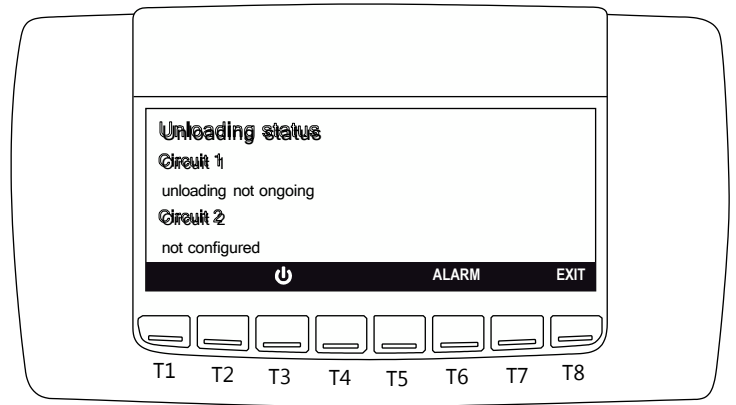



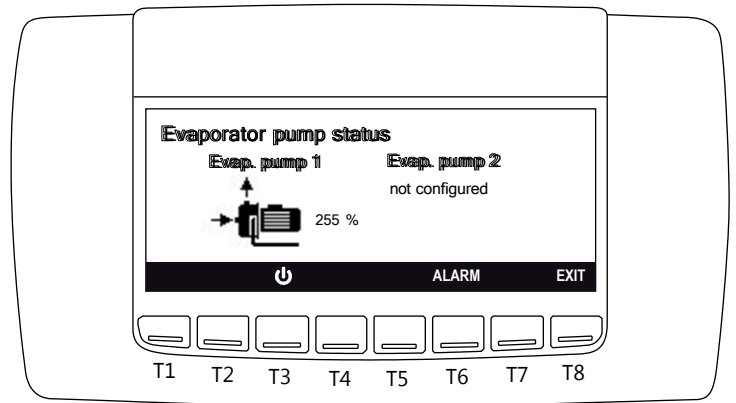
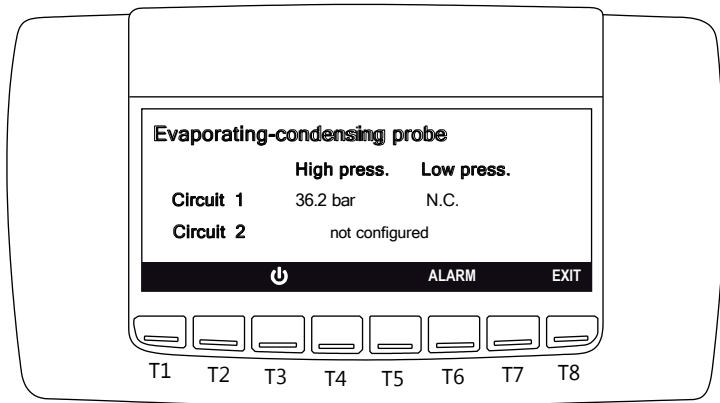



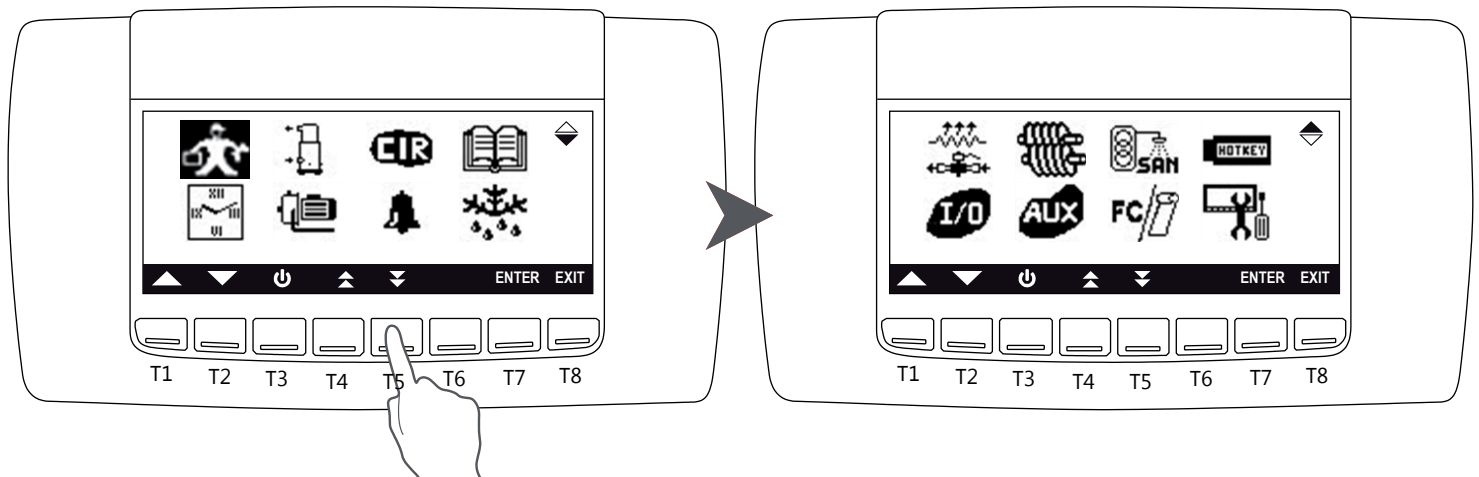









Evaporator pump status





SERVICE KEY





Press the **SERVICE** key to access the following menus:

	Setting parameters (for service only)		Electrical heater and pump down valve status
	Time and date setting		I/O status (Inputs and Outputs)
	Compressors status		Screw compressor information (Not configured)
	Pumps		Auxiliary outputs
	Circuit maintenance		Domestic hot water (if available)
	Display of alarms		NOT USED
	Alarm history		Upload and download parameter map with Hot Key
	Defrost (if available)		Control panel



Press  key to display all the menu available.

To modify and set the parameters move the cursor using the  and , press **ENTER**, to select the required menu, and then **SET** to select the desired value.

Change the parameters by pressing the  and , and then press **SET** again to confirm.

Press the **EXIT** key to return to the main menu.

SERVICE PARAMETER SETTING

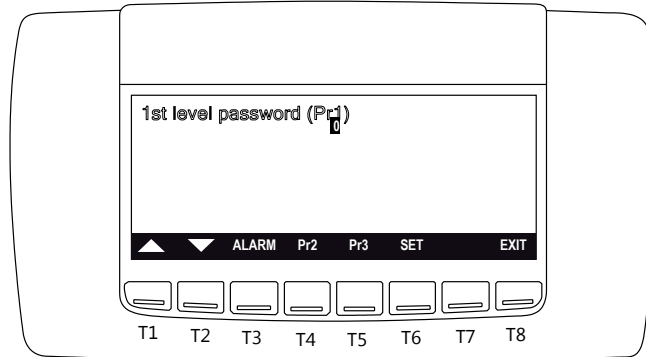

To enter the service menu select  moving between the icons with the  and,  keys and press **ENTER**.
The system prompts you to enter the password to access different levels of security.

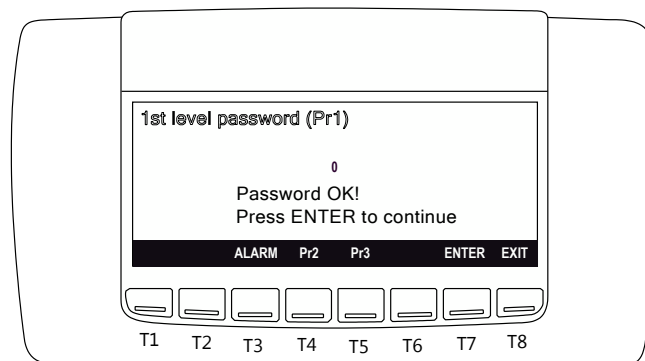

The first level will allow some parameters to be modified such as heating set points. Press the **SET** key, then  to modify the password to 1 then press the **SET** key again to confirm.

The display will show:



Press  and  to scroll through the different parameters. Using password level 1 you can only change the set point (**St**), dynamic set point (**Sd**) and DHW circuit parameters (**FS**), the unit must be switched on. Press **ENTER** to enter the group of parameters.



Other parameters can only be set using the service password by a competent suitably trained service engineer.

Parameter list:

CODE	MEANING	CODE	MEANING
St	Set point	US	Auxiliary output
dP	Main visualization	FA	Fan
CF	Configuration	Ar	Antifreeze
Sd	Dynamic set	dF	Defrost
ES	Energy saving	FS	Sanitary water
Cr	Compressor racks	AL	Alarms
CO	Compressor		

To modify the value of the parameter press ▲ or ▼ to select the programme to modify then press **SET**, the value will start blinking. Press ▲ and ▼ to modify then press **SET** again to confirm.

The values shown in the group set point (St) are: Summer set point (St01), Winter set point (St04) Summer regulation band (St07) and Winter regulation band (St08)

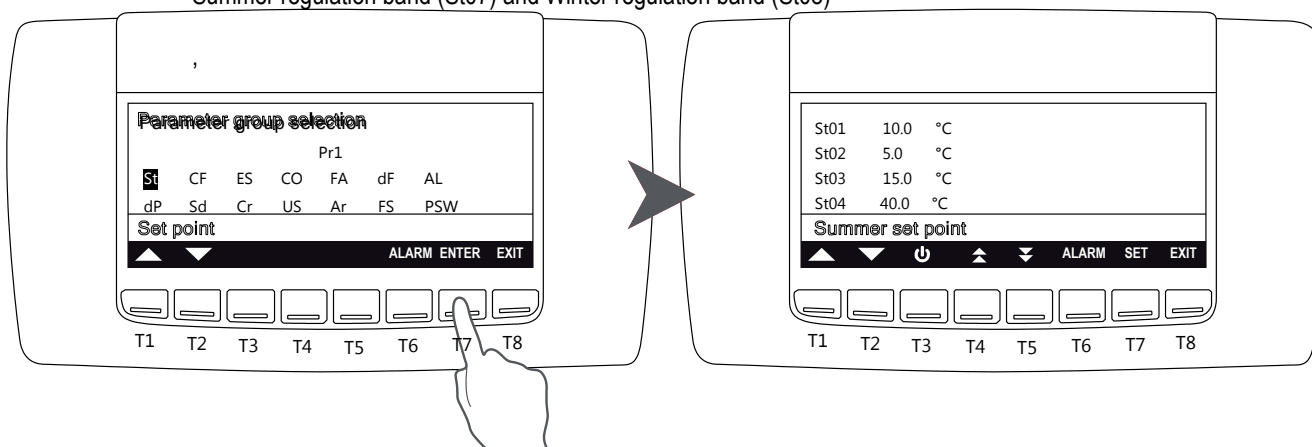

The values available in the group of parameters “Dynamic set point” (**Sd**) are: dynamic set point: summer offset (Sd01), dynamic set point: winter offset (Sd02), dynamic set point: summer outside temp. (Sd03), dynamic set point: winter outside temp. (Sd04), dynamic set point: summer differential temp. (Sd05) and dynamic set point: winter differential temp.(Sd06).
For more information about the parameters see 0and 0

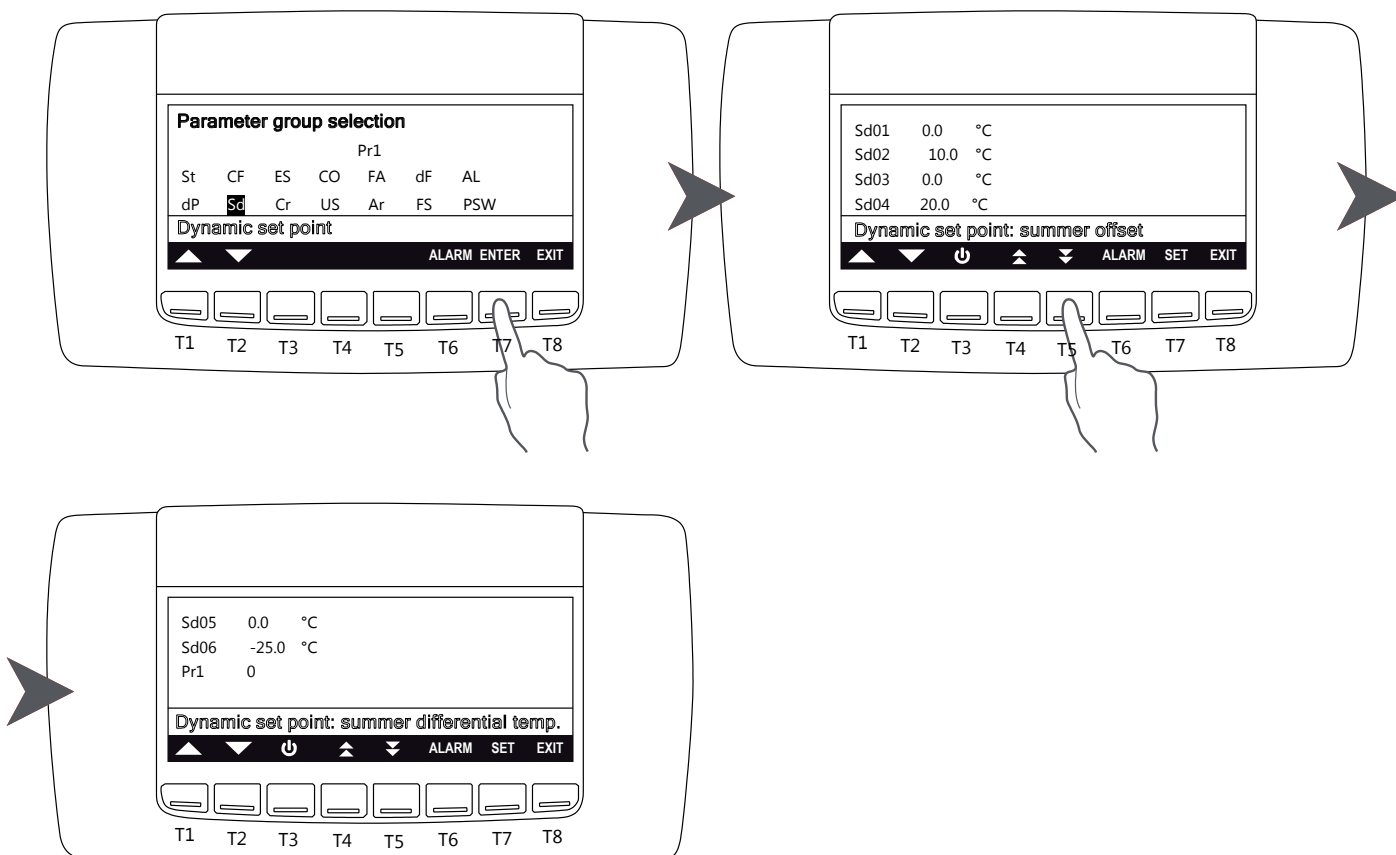

WEATHER COMPENSATION FUNCTION

This function activates the weather compensation sensor in order to optimise the efficiency of the unit. The unit will automatically modify the setpoint value in relation to the external air temperature: This function makes it possible to save energy and to operate the unit in severe ambient conditions. This function is only active in heating mode.

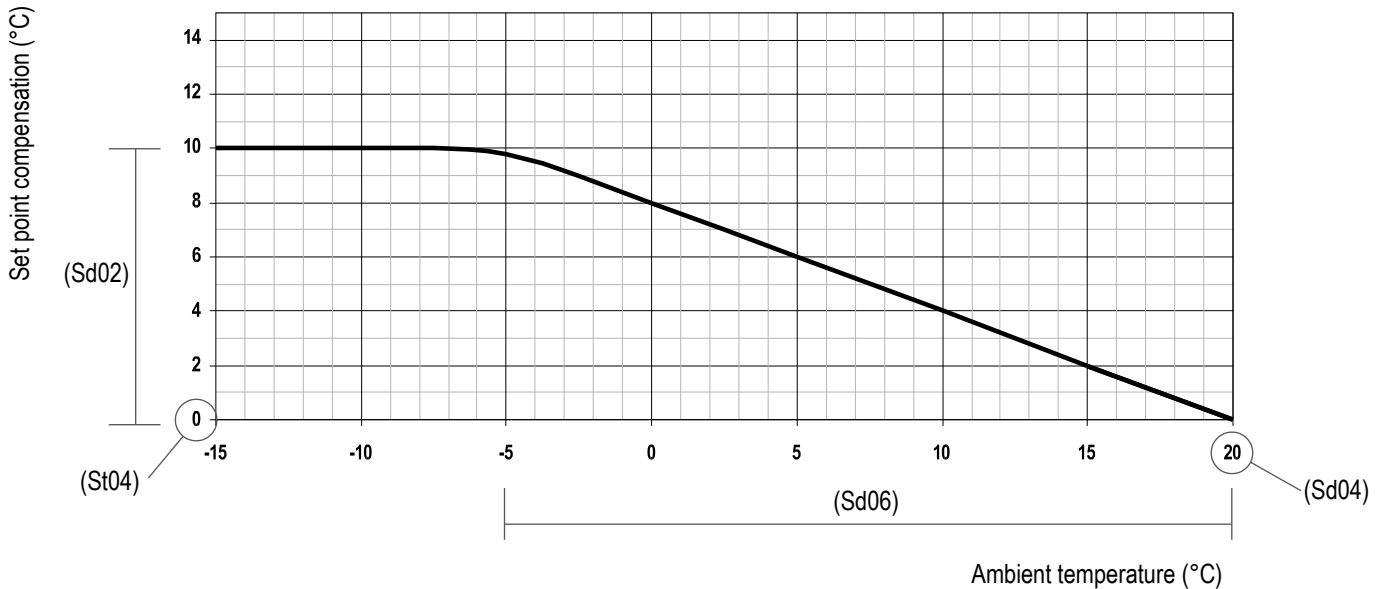

All units are factory set with the weather compensation function activated. The slope starts at +20°C with a differential of 10°C







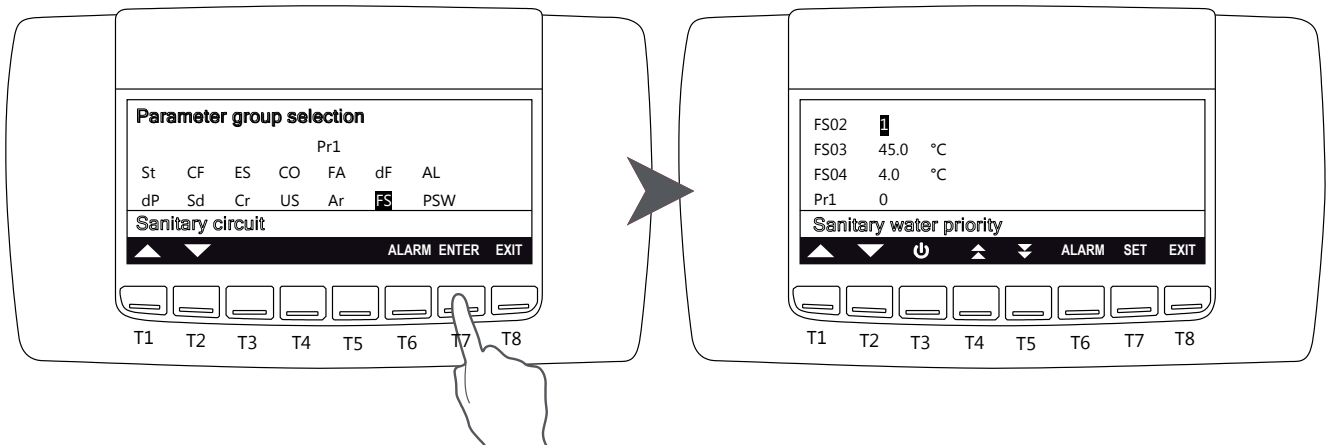

With the energy saving mode activated, if the SET key is pressed twice the bottom of the display shows the SETTR (weather compensated set point) label that is the specific set point calculated by the microprocessor control for the measured ambient temperature condition

The values shown in the group "Sanitary circuit" (Domestic hot water) are:

- Sanitary water priority (FS02)
- Sanitary water set point (FS03)
- Sanitary water proportional band (FS04)





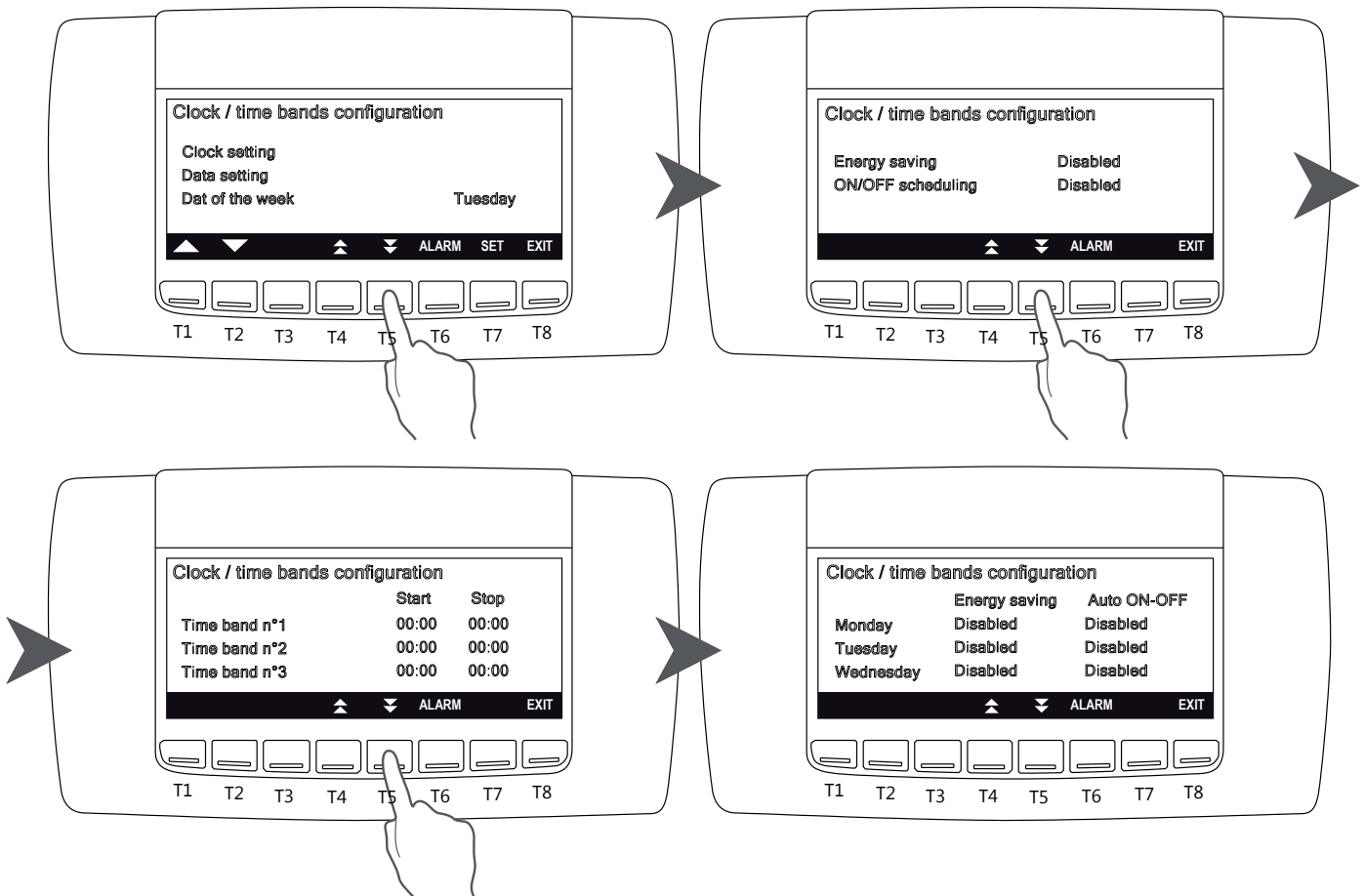

SETTING THE DATE AND TIME

To enter the menu select  moving the icons with the keys  and  and press **ENTER**. Press  and  to select the value you require then press **SET**. The selected parameter will start blinking, press keys  and  to set the value and then press **SET** to confirm.

By pressing,  it is possible to read the information about energy saving, ON/OFF scheduling and time bands. To modify the hour of the time band and to enable the function you first need to enter a password. If you do not have the password, you can only view the parameters set.



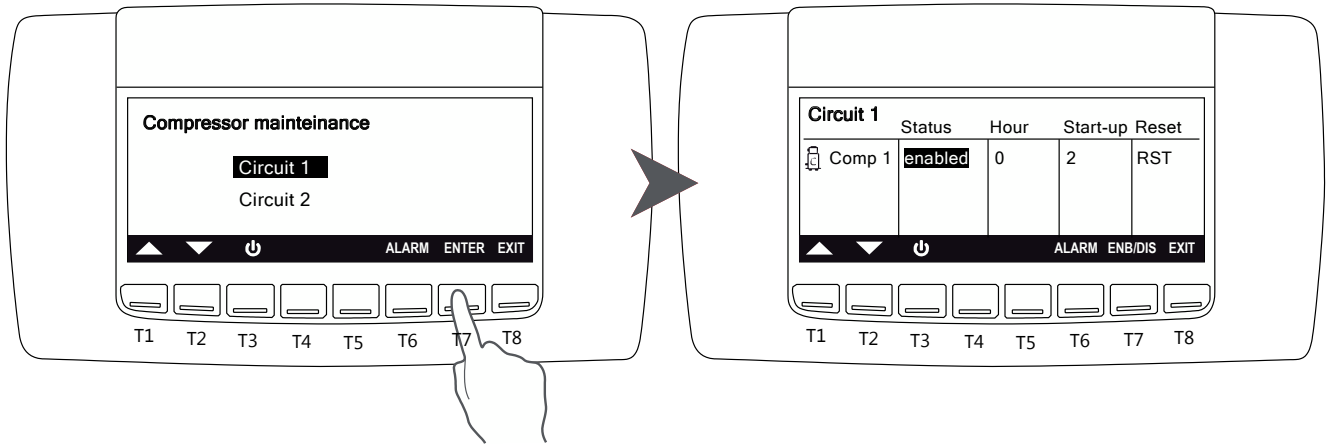

COMPRESSOR MAINTENANCE

To enter the menu select  moving between the icons with the keys  and  and press **ENTER**. It is possible to display the compressor working hours and number of activations. Select the circuit with the keys  and  then press **ENTER** to display the parameters. The function **ENB/DIS** is only available after the correct password has been entered.



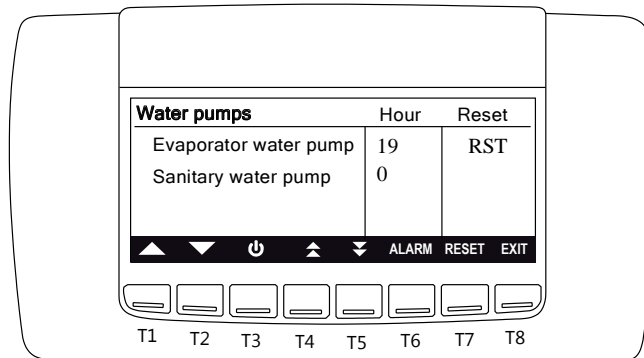

WATER PUMPS

To enter the menu select  moving between the icons with the keys  and  and press **ENTER**. It is possible to display the working hours of the circulating pumps. The function **RESET** is only available after the correct password has been entered.



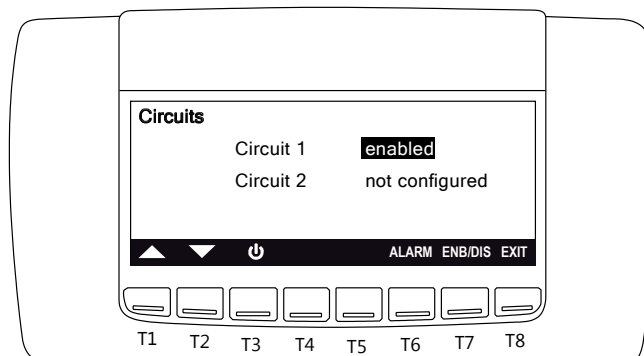

CIRCUIT MAINTENANCE

To enter the menu select  moving between the icons with the keys  and  and press **ENTER**. It is possible to display the status of each circuit. The function **ENB/DIS** is only available after the correct password has been entered.





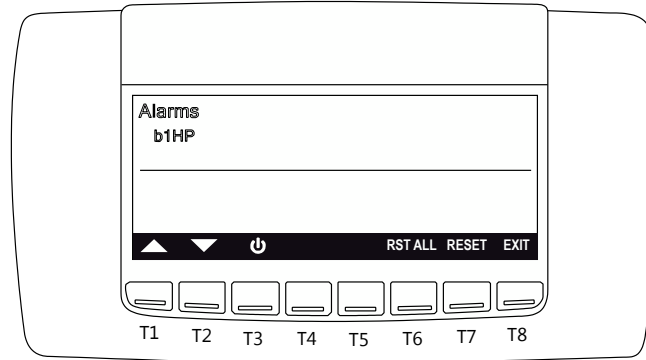

6.7.6 Alarms

To enter this menu select  moving between the icons with the keys  and  and press **ENTER**.

For the management of alarms see 0.





14.1.8 ALARM LOG

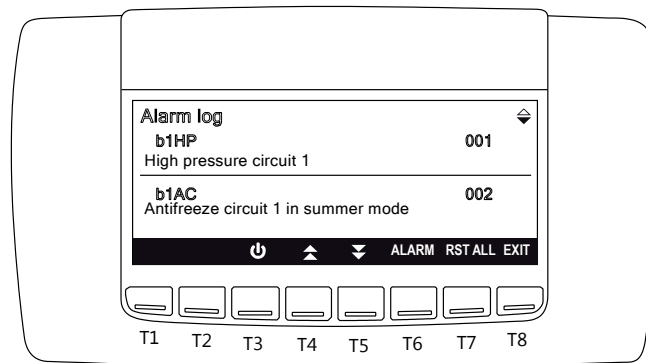

To enter the menu select  moving between the icons with the keys  and  and press **ENTER**. By pressing  and  it is possible to see the last 99 alarms. The function **RST/ALL** that resets the alarm log is only available after the correct password has been entered.



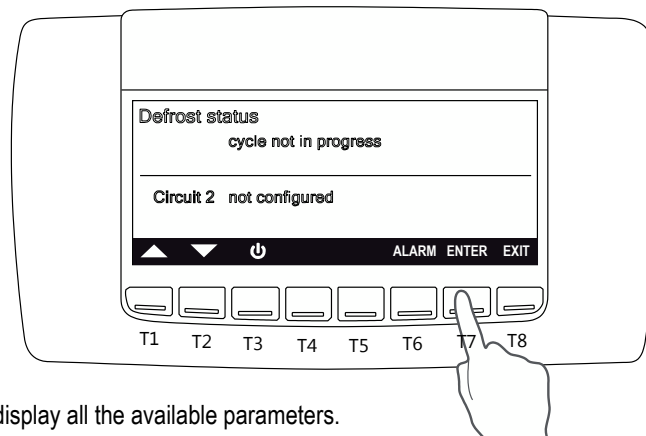

DEFROST

To enter the menu select  moving between the icons with the keys  and  and press **ENTER**. For each circuit it is possible to read the status of the defrost function and after selecting the circuit and pressing the **ENTER** key it is possible to display some parameters relating to the defrosting of the circuit.



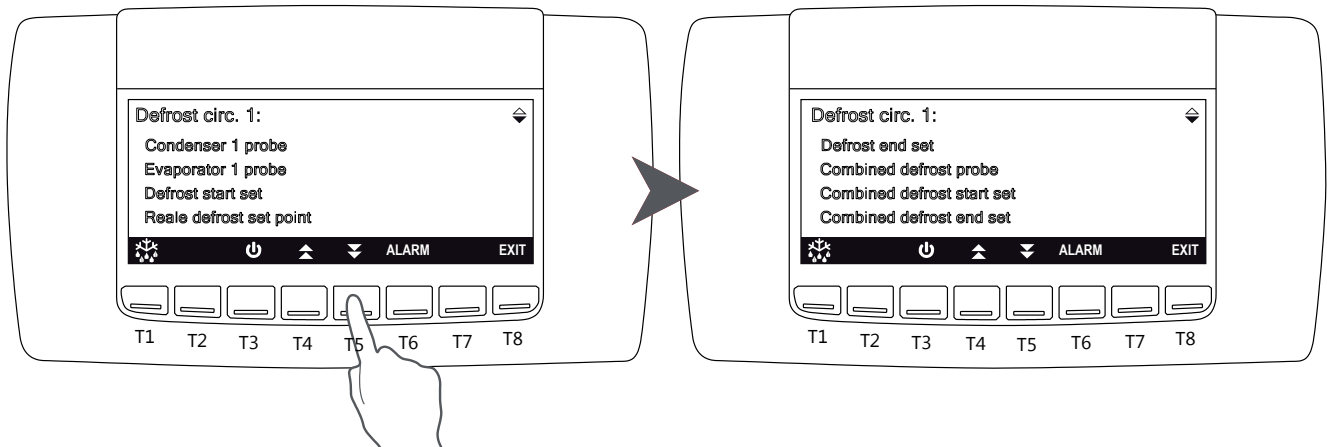

Press  and  to display all the available parameters.

Press  and  to display all the available parameters.



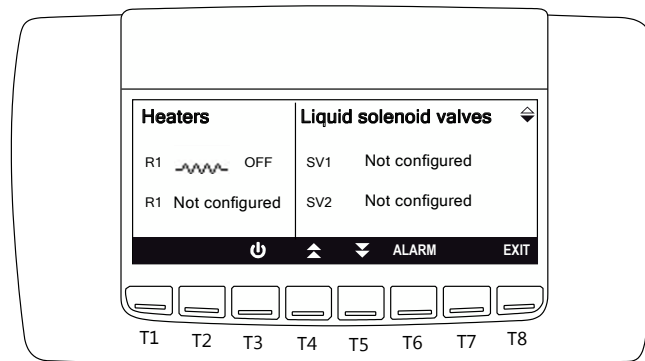

ELECTRICAL HEATER

To enter the menu select  moving between the icons with the keys  and  and press **ENTER**. This will allow the electrical heater status to be seen.





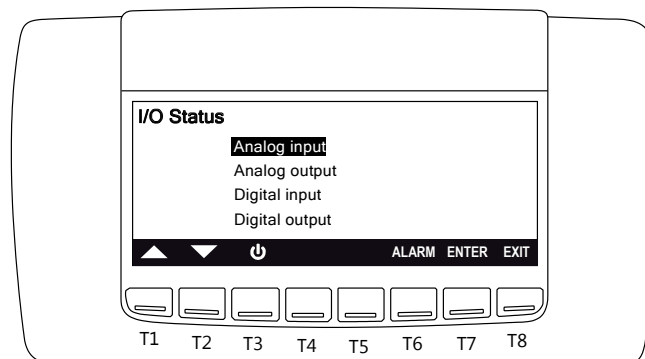

STATUS INPUT/OUTPUT

To enter the menu select  moving between the icons with the keys  and  and press **ENTER**. It is possible to display probes status, analogue input and output, digital input and output.



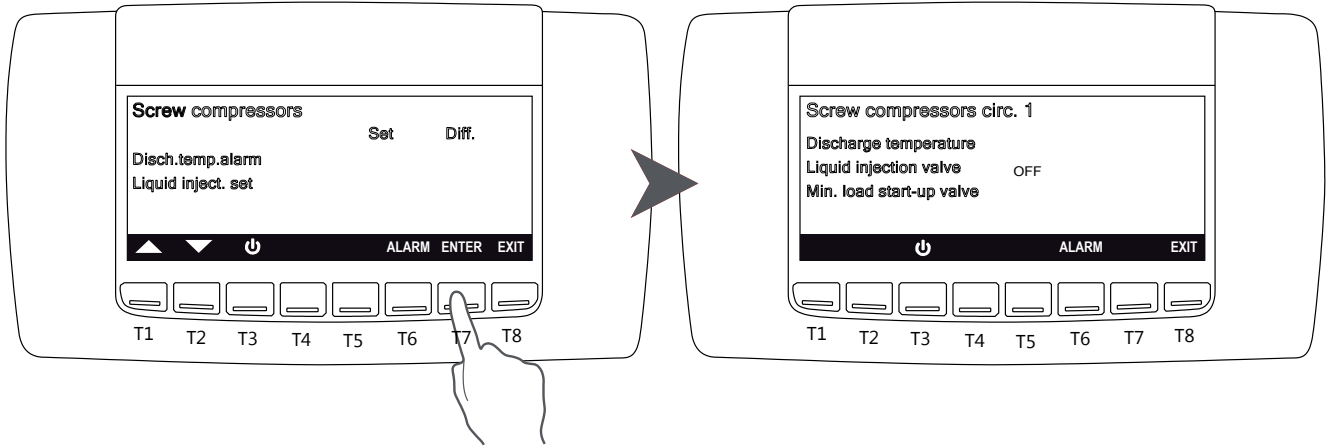

SCREW COMPRESSOR

To enter this menu select  moving between the icons with the keys  and  and press **ENTER**. In the main screen it is possible to display the discharge temperature and the liquid injection set point. Press  and  keys to select the required circuit than press **ENTER** key to read the discharge temperature and the status of the valves.



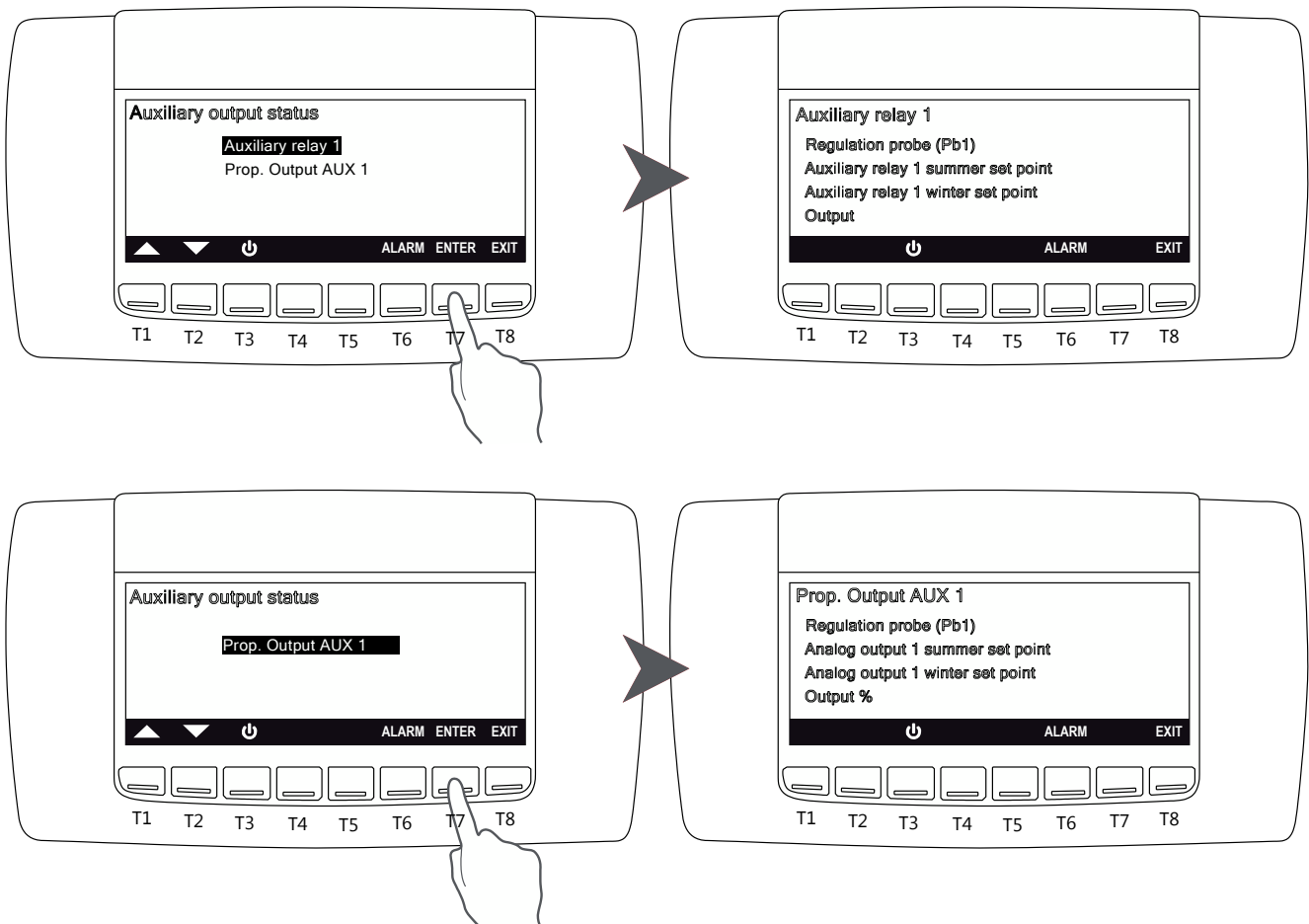

AUXILIARY OUTPUT

To enter the menu select  moving between the icons with the keys  and  and press **ENTER**. It is possible to read information relating to any auxiliary outputs.



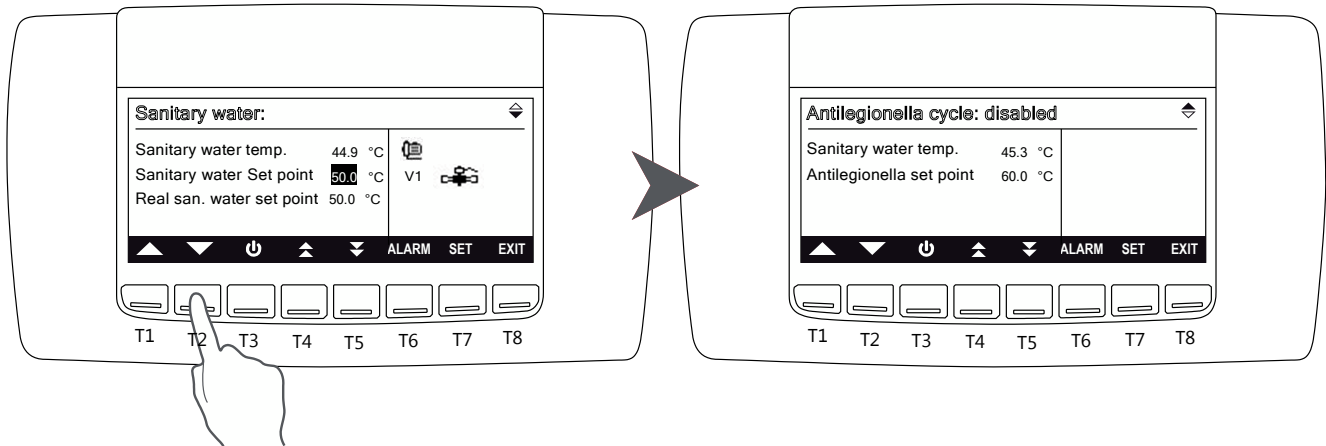

SANITARY (DOMESTIC) HOT WATER

To enter the menu select  moving between the icons with the keys  and  and press **ENTER**. It is possible to read information relating to the domestic hot water settings (if activated). Press **SET** key to modify the values.



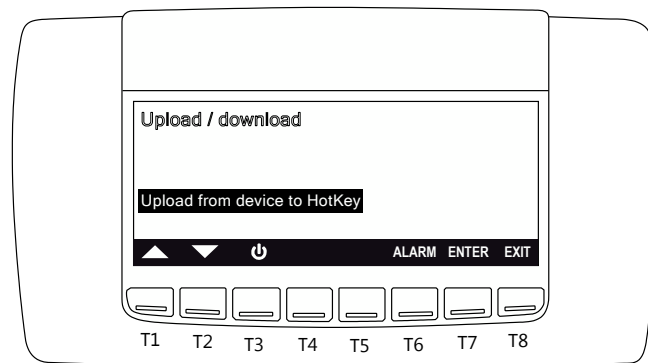

UPLOAD/DOWNLOAD

To enter the menu select  moving between the icons with the keys  and  and press **ENTER**. Competent service engineers only can access this function.



CONTROL PANEL

To enter the menu select  moving between the icons with the keys  and  and press **ENTER**.

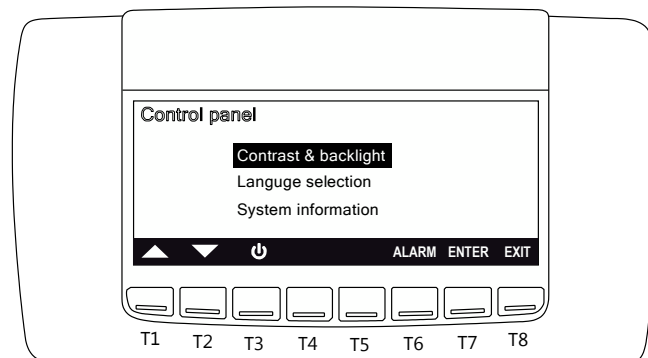

ACOUSTIC SIGNAL SILENCE

Pressing and releasing any of the keys will silence the alarm buzzer; this does not reset the alarm condition.

15 UNIT MAINTENANCE

GENERAL WARNINGS

Maintenance can:

- Keep the equipment operating efficiently
- Prevent failures
- Increase the equipment life



It is advisable to maintain a record book for the unit, which details all operations performed on the unit as this will facilitate troubleshooting.



Maintenance must be carried out in compliance with all requirements of the previous paragraphs.



Use personal protective equipment required by regulations as compressor casings and discharge pipes are at high temperatures. Coil fins are sharp and present a cutting hazard.



If the unit is not to be used during the winter period, the water contained in the pipes may freeze and cause serious damage. In this event, fully drain the water from the pipes, checking that all parts of the circuit are empty including any internal or external traps and siphons.

ACCESS TO THE UNIT

Access to the unit once installed, should only be possible to authorized operators and technicians. The site owners are (once the unit is installed) fully responsible for all safety rules given in this manual and regulations. If it is not possible to prevent access to the machine by outsiders, a fenced area around the machine at least 1.5 meters away from external surfaces in which operators and technicians only can operate must be provided.

PERIODICAL CHECKS



The start-up operations should be performed in compliance with all requirements of the previous paragraphs.



All of the operations described in this chapter **MUST BE PERFORMED BY TRAINED PERSONNEL ONLY**. Before commencing service work on the unit, ensure that the electric supply is disconnected. The top case and discharge line of compressor are usually at high temperature. Care must be taken when working in their surroundings. Aluminium coil fins are very sharp and can cause serious wounds. Care must be taken when working in their surroundings. After servicing, replace the cover panels, fixing them with locking screws.

15.1.1 EVERY SIX MONTHS

It is advisable to perform periodic checks in order to verify the correct working of the unit.

- Check that safety and control devices work correctly as previously described.
- Check all the terminals on the electric board and on the compressor are properly fixed.
- Check and clean the sliding terminals of the contactors.
- Check for water leaks in the hydraulic system.
- Check correct operation of the flow switch and clean the strainers on the pipework.
- Check the compressor crankcase heater has the proper supply and is functioning correctly.
- Check the state of the finned coil, removing any debris or leaves. If possible, use compressed air to blow through in the opposite direction to the airflow. If the coil is heavily clogged, clean it with a low-pressure washer, taking care to avoid damaging the aluminium fins.
- Check the state of the finned coils metallic filters (Optional), removing any debris or leaves. If possible, use compressed air to blow through in the opposite direction to the airflow. If the coil is heavily clogged, clean it with a low-pressure washer, taking care to avoid damaging the aluminium fins.
- Check mounting of fan blades and their balancing.
- Check the colour of the sight glass core (green=no moisture, yellow=moisture present): if it has a yellow colour, change the refrigerant filter.

15.1.2 END OF SEASONS OR UNIT SWITCHED OFF:



If the unit is to be left out of commission for a long period, the hydraulic circuit should be drained down. This operation is compulsory if the ambient temperature is expected to drop below the freezing point of the fluid in the circuit (water or Glycol mix).

16 REFRIGERANT CIRCUIT REPAIR



If the refrigerant circuit is to be emptied, the entire refrigerant must be recovered using the correct equipment.

For leak detection, the system should be charged with nitrogen using a gas bottle with a pressure reducing valve, until 15 bar pressure is reached. Any leakage is detected using a bubble leak finder. If bubbles appear discharge the nitrogen from the circuit before brazing using the proper alloys.



Never use oxygen instead of nitrogen: explosions may occur.

Site assembled refrigerant circuits must be assembled and maintained carefully, in order to prevent problems.

Therefore:

- Avoid oil replenishment with products that are different from that specified and that are pre-loaded into the compressor.
- In the event of a gas leakage on machines using refrigerant R407C, even if it is only a partial leak, do not top up. The entire charge must be recovered, the leak repaired and a new refrigerant charge weighed in to the circuit.
- When replacing any part of the refrigerant circuit, do not leave it exposed for more than 15 minutes.
- It is important when replacing a compressor that the task be completed within the time specified above after removing the rubber sealing caps.
- When replacing the compressor following a burn out, it is advisable to wash the system with appropriate products including a filter for acid.
- When under vacuum do not switch on the compressor.

17 DECOMMISSIONING

DISCONNECT THE UNIT



All decommissioning operations must be performed by trained personnel in accordance with the national legislation in force in the country where the unit is located.

- Avoid spills or leaks into the environment.
- Before disconnecting the machine please recover:
 - the refrigerant gas;
 - Glycol mixture in the hydraulic circuit;
 - The compressor lubricating oil.

Before decommissioning, the machine can be stored outdoors, providing that it has the electrical box, refrigerant circuit and hydraulic circuit intact and closed.

18 DISPOSAL, RECOVERY AND RECYCLING

The frame and components, if unusable, should be taken apart and sorted by type, especially copper and aluminium that are present in large quantities in the machine.



All materials must be recovered or disposed in accordance with national regulations.

19 RAEE DIRECTIVE



- The RAEE Directive requires that the disposal and recycling of electrical and electronic equipment must be handled through a special collection, in appropriate centres, separate from that used for the disposal of mixed urban waste.
- The user has the obligation not to dispose of the equipment at the end of the useful life as municipal waste, but to send it to a special collection centre.
- The units covered by the RAEE Directive are marked with the symbol shown above.
- The potential effects on the environment and human health are detailed in this manual.
- Additional information can be obtained from the manufacturer.

20 TROUBLESHOOTING

FAULT FINDING

All units are checked and tested at the factory before shipment, however, during operation an anomaly or failure can occur.



Do not reset an alarm until the cause of the fault has been repaired; repeated reset may result in serious damage to the unit.

CODE	ALARM DESCRIPTION	CAUSE	SOLUTION
ACF1	Configuration Alarm	Incorrect configuration of microprocessor control system	Contact Lochinvar Technical support
ACF2	Configuration Alarm		
ACF3	Configuration Alarm		
ACF4	Configuration Alarm		
ACF5	Configuration Alarm		
ACF6	Configuration Alarm		
ACF7	Configuration Alarm		
ACF8	Configuration Alarm		
ACF9	Configuration Alarm		
AEE	Eeprom alarm	Severe hardware damage in the microprocessor control system	Switch the unit off, wait 5 seconds and turn on again. If the alarm is still present contact Lochinvar Technical support
AEFL	User water flow switch alarm	There is air and/or dirt in the user Hydraulic system	Remove all air and check filters and clean as required
AEU _n	Compressor unloading alarm	User water temperature too high	Reduce user water temperature
AHFL	DHW Flow switch alarm	There is air and/or dirt in the user Hydraulic system	Remove all air and check filters and clean as required
AP1	Alarm- inlet water temperature sensor	Incorrect electrical connection or faulty sensor	Check the electrical connections between the sensor and terminal board, if all Ok replace the sensor
AP10	Alarm-safety DHW sensor		
AP2	Alarm-water outlet temperature sensor		
AP3	Alarm-pressure transducer		
AP4	Alarm-finned coil sensor/defrost sensor		
AP5	Alarm-DHW inlet temperature sensor		
AP6	Alarm-DHW outlet temperature sensor		

CODE	ALARM DESCRIPTION	CAUSE	SOLUTION
AP7	Alarm-ambient sensor	Incorrect electrical connection or faulty sensor	Check the electrical connections between the sensor and terminal board, if all Ok replace the sensor
AP8	not used		
AP9	not used		
AtE1	Evaporator water pump 1 overload		
AtE2	Evaporator water pump 2 overload		
B1 HP	High pressure switch circuit 1	Insufficient flow in the user circuit, insufficient domestic hot water circuit flow	restore correct user circuit water flow or DHW circuit water flow
B1ah	Anti-freeze alarm circuit 1	water temperature too low	check user temperature set point
b1dF	Maximum defrost time exceeded	Defrost time too long, Ambient temperature outside working limits, Refrigerant charge leak	Check defrost set point, wait for normal working conditions, find leak and repair
b1hP	High pressure transducer alarm	Transducer defective	Replace transducer
B1LP	Low pressure switch	Refrigerant charge leak	Find leak and repair
b1IP	Low pressure transducer alarm	Transducer defective	Replace transducer
b1tF	Overload source fan alarm	Fan input current outside operational limits	Check source fan for problems and replace if required
C1tr	Compressor 1 overload	Compressor 1 input current outside operational limits	Replace the compressor
C2tr	Compressor 2 overload	Compressor 2 input current outside operational limits	

NOTES



IMPORTANT INFORMATION

These instructions must be read and understood before installing, commissioning, operating or maintaining the equipment.

