

# TECHNICAL PRODUCT SUBMITTAL

## Herald HCB176CE



Nominal Input (net)	kW	158.4
Nominal Input (gross)	kW	175.8
Gas Flow Rate (natural gas)	m3/hr	16.8
Output @50/30°C	kW	162.1
Output @80/60°C	kW	154
<b>EFFICIENCY DATA-Part L2</b>		
Seasonal Efficiency (According EN15502) Gross	%	95
<b>EFFICIENCY DATA-ErP and Energy Label</b>		
Ecodesign Energy Label rating		n/a
Seasonal space heating energy efficiency	%	95
<b>GENERAL DATA</b>		
NOx emission @0% O2 According to EN15502	mg/kWh	36
Dimensions (height)	mm	1080
Dimensions (width)	mm	395
Dimensions (depth)	mm	925
Water Content	litres	15.9
Weight (empty)	kg	154
Weight (full)	kg	170
Flow Connection (inches)	BSP	2
Return Connection (inches)	BSP	2
Gas Connection (inches)	BSP	1
Electrical Requirements		230V /1Ph/ 50hz
Power Consumption	W	322
Sound Power Level	LWA(db)	69
Maximum Flue Gas Temperature	°C	120
Max Flow Temperature	°C	88
Working Pressure Minimum	bar	0.5
Working Pressure Maximum	bar	11

**Herald boiler** must be installed and maintained in line with the Installation Commissioning and Maintenance Instructions which are available on the Literature & Downloads section of [www.lochinvar.ltd.uk](http://www.lochinvar.ltd.uk)

Particular attention should be made to:-

- Correct sizing of associated buffer vessel
- Dimensions and clearances
- Vented and Unvented installation requirements
- maintenance

### **ErP and Warranty**

ErP Data including Product Fiche and Energy Labels where applicable and Warranty information are also available at [www.lochinvar.ltd.uk](http://www.lochinvar.ltd.uk)

# TECHNICAL PRODUCT SUBMITTAL

## Herald HCB176CE

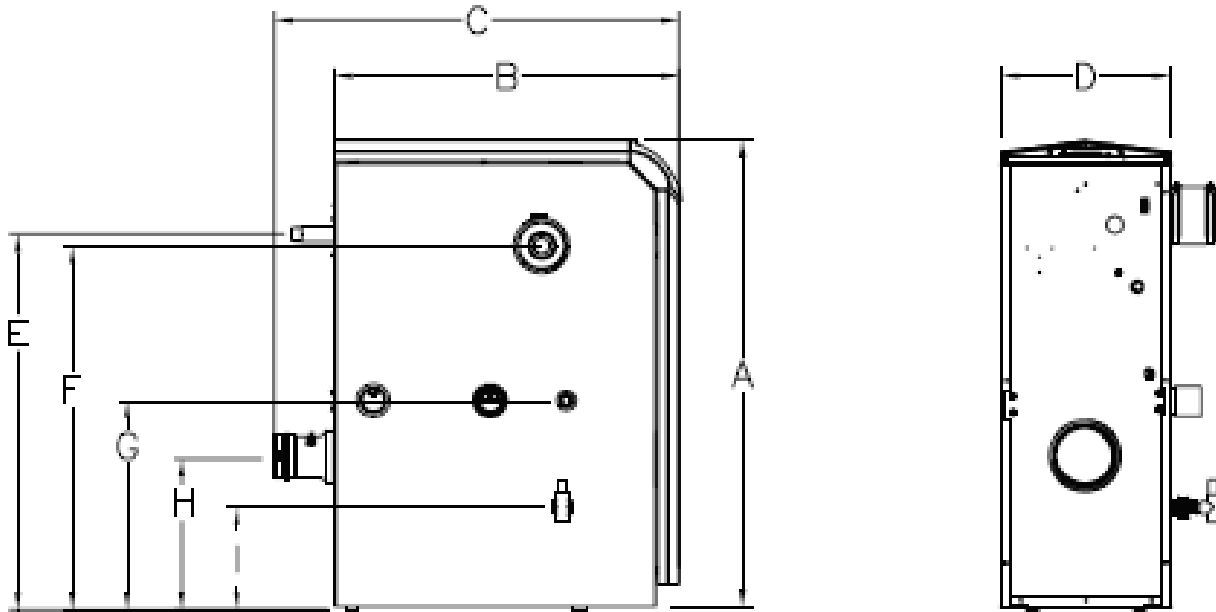

Description			Model					
			HCB86CE	HCB116CE	HCB146CE	HCB176CE	HCB206CE	HCB236CE
A	Height	mm	1080	1080	1080	1080	1080	1080
B	Depth	mm	503	688	798	925	1024	1153
C	Depth inc Flue Outlet	mm	715	828	938	1065	1164	1293
D	Width	mm	395	395	395	395	395	395
E	Gas Connection	mm	788	860	887	833	833	834
F	Air Inlet	mm	860	860	887	915	915	915
G	Water Connections	mm	477	477	477	477	477	477
H	Flue Outlet	mm	350	350	350	350	350	350
I	Condense Outlet	mm	230	230	230	230	230	230

Connection Sizes			Model					
			HCB86CE	HCB116CE	HCB146CE	HCB176CE	HCB206CE	HCB236CE
E	Gas Connection	BSP	¾"	1"	1"	1"	1"	1"
F	Air Inlet	mm	100	100	150	150	150	150
G	Water Connections	BSP	2"	2"	2"	2"	2"	2"
H	Flue Outlet	mm	100	100	150	150	150	150
I	Condense Outlet	PVC	½"	½"	½"	½"	½"	½"